

VITE / PUMP 2  
1760 | 07.16

# SFA



## SANIVITE®

## SANIPUMP2®

- |    |                                |    |                                      |    |                               |
|----|--------------------------------|----|--------------------------------------|----|-------------------------------|
| FR | NOTICE D'INSTALLATION          | SE | INSTALLATIONSANVISNING               | RO | MANUAL DE INSTALARE           |
| UK | INSTALLATION INSTRUCTIONS      | DK | INSTALLATIONSVEJLEDNING              | CZ | NÁVOD K INSTALACI A POUŽÍVÁNÍ |
| DE | INSTALLATIONSHINWEISE          | NO | INSTALLASJONSANVISING                | TR | KURULUM KILAVUZU              |
| IT | ISTRUZIONI PER L'INSTALLAZIONE | FI | ASENNUSOHJEET                        | CN | 用户应保留安装指南以备用                  |
| ES | MANUAL DE INSTALACIÓN          | HU | FELSZERELÉSI ÉS KEZELÉSI ÚTMUTATÓ    | KR | 설치내용서                         |
| BR | PT                             | PL | INSTRUKCJA INSTALACJI                | HR | UPUTA ZA INSTALACIJU          |
| NL | INSTALLATIE VOORSCHRIFTEN      | RU | ИНСТРУКЦИЯ ПО МОНТАЖУ И ЭКСПЛУАТАЦИИ | AR | بى ئىرتىلا قىرط               |

CE

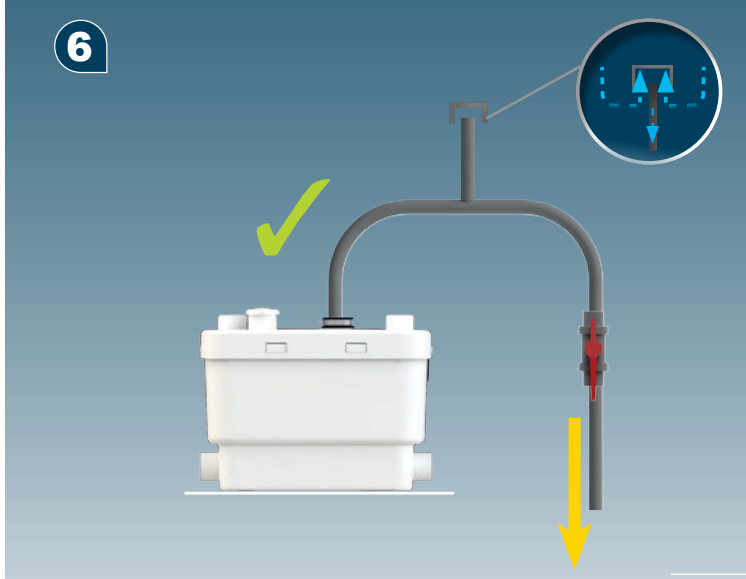
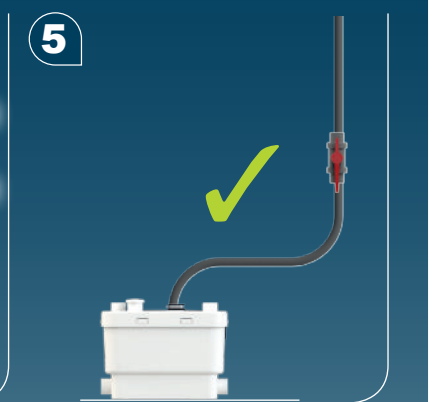
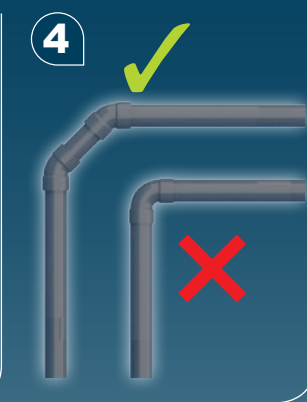
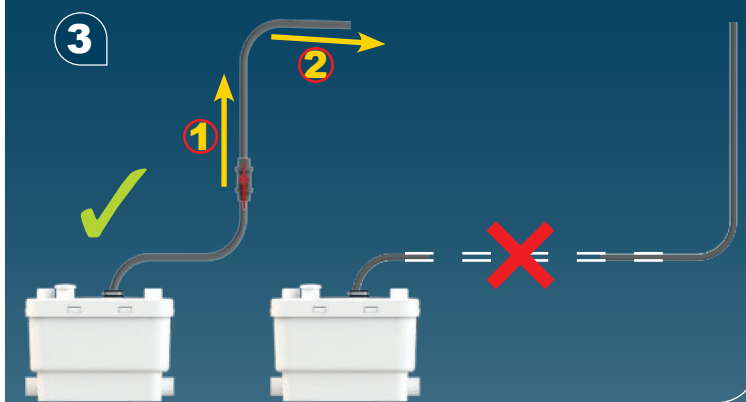
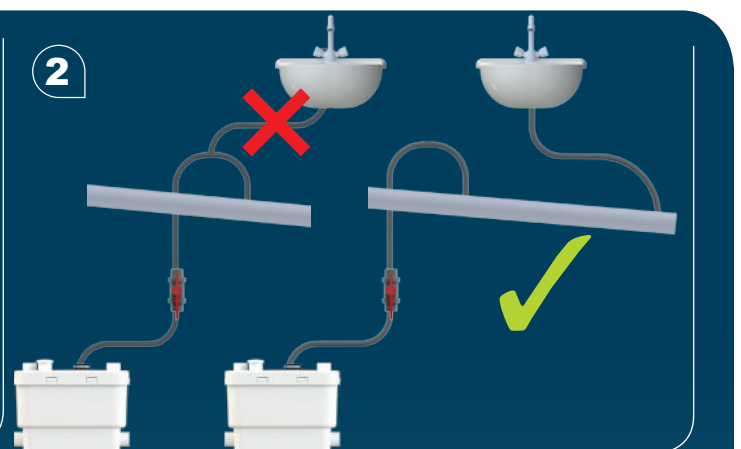
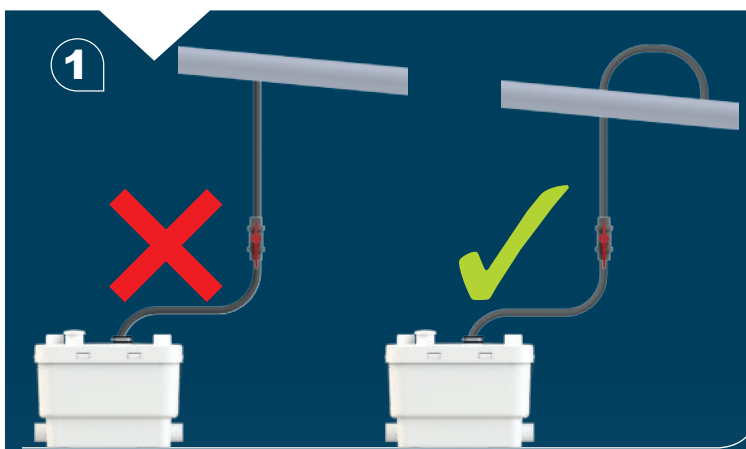
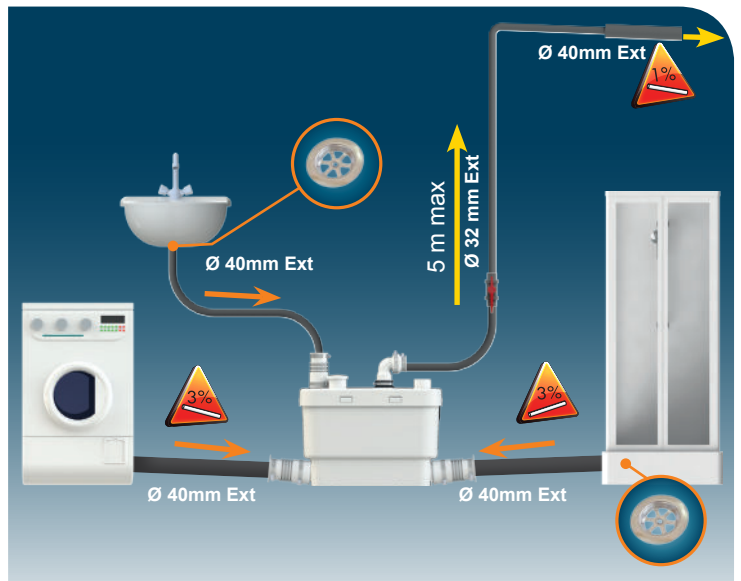
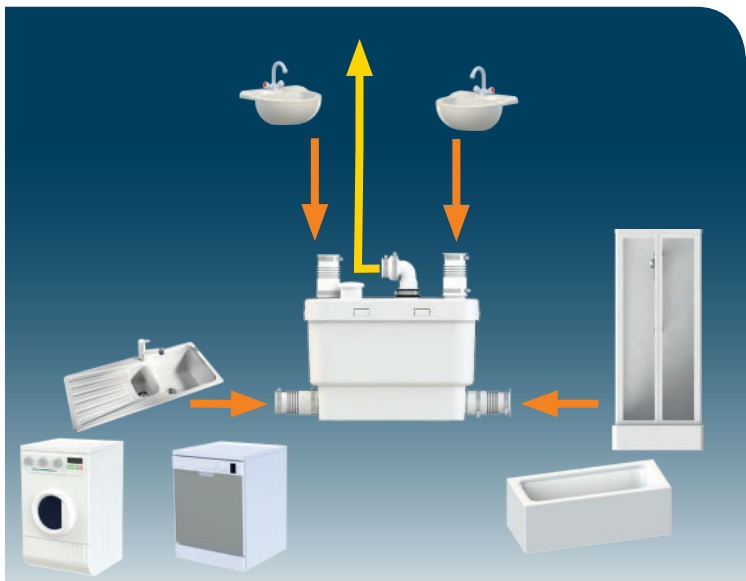

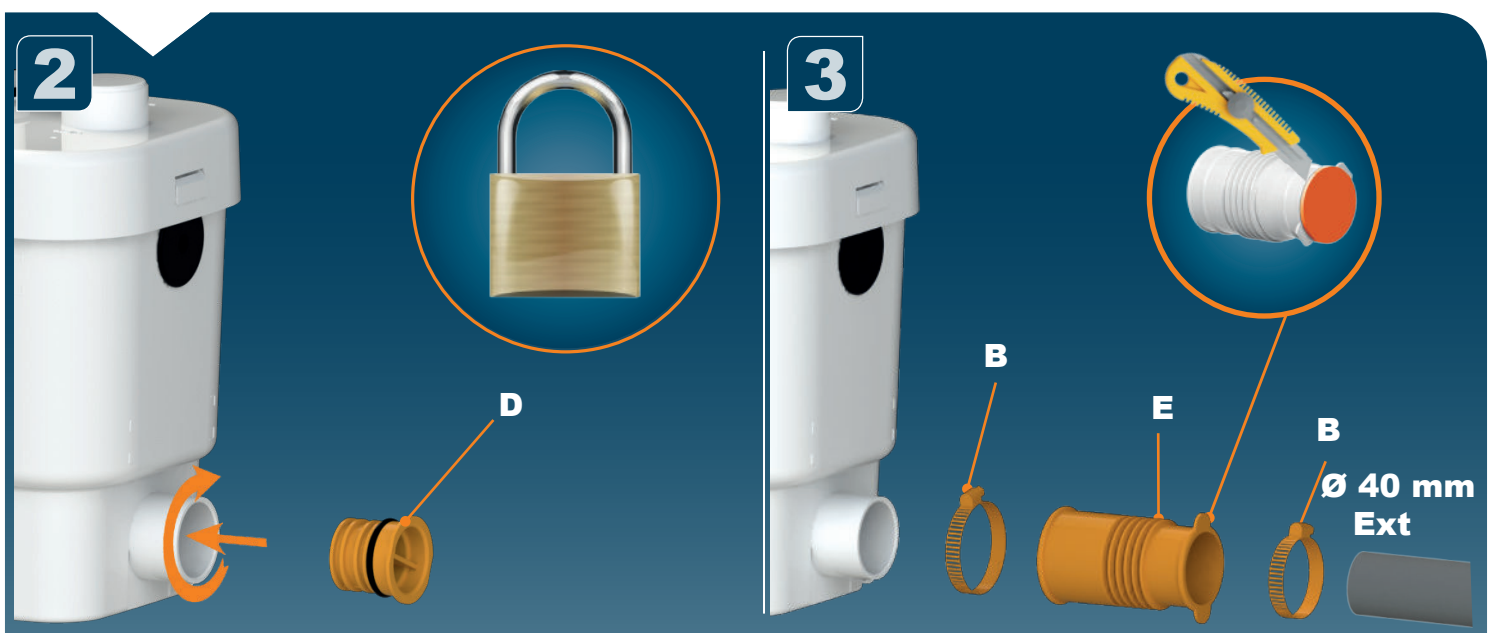
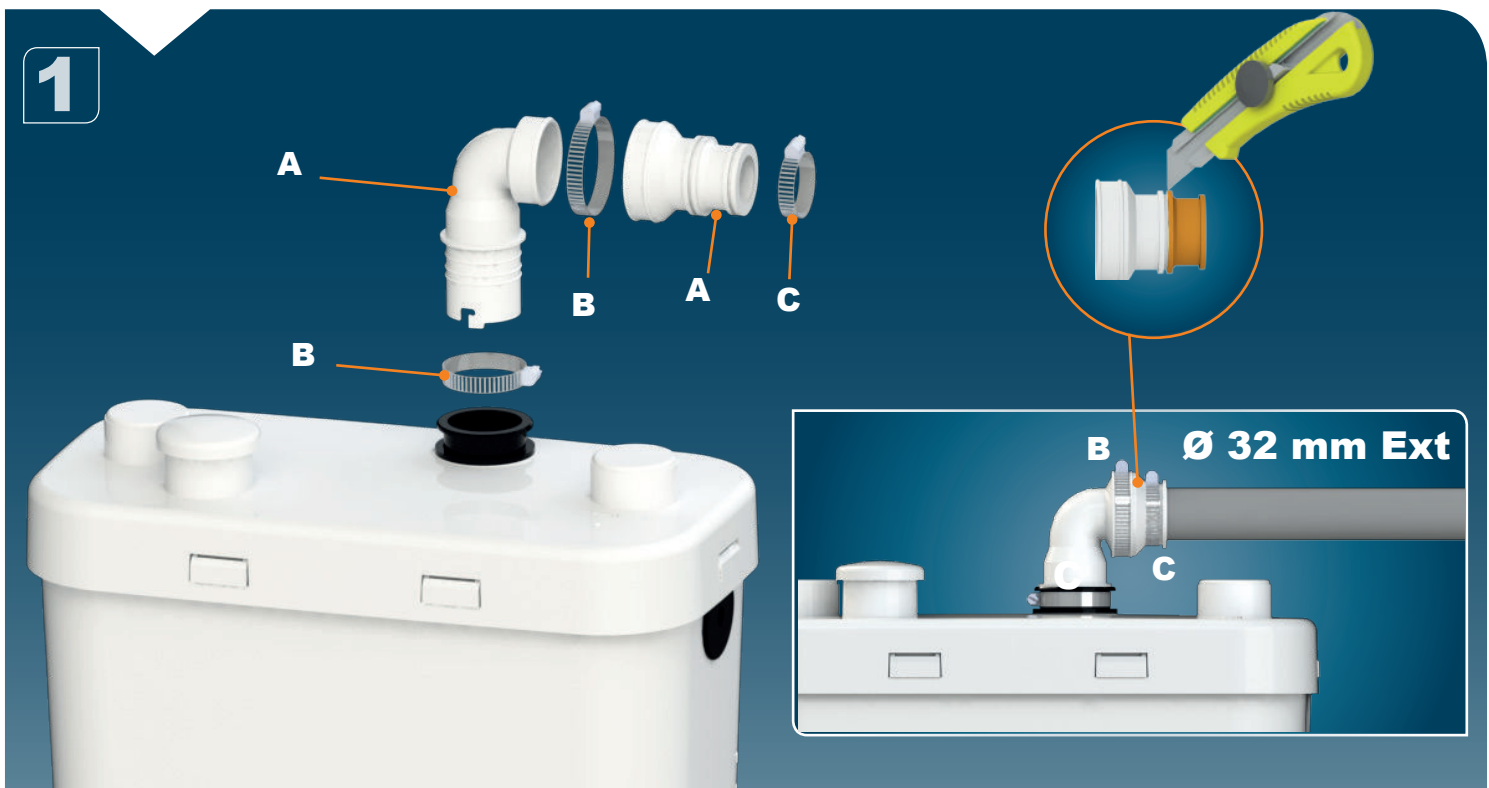
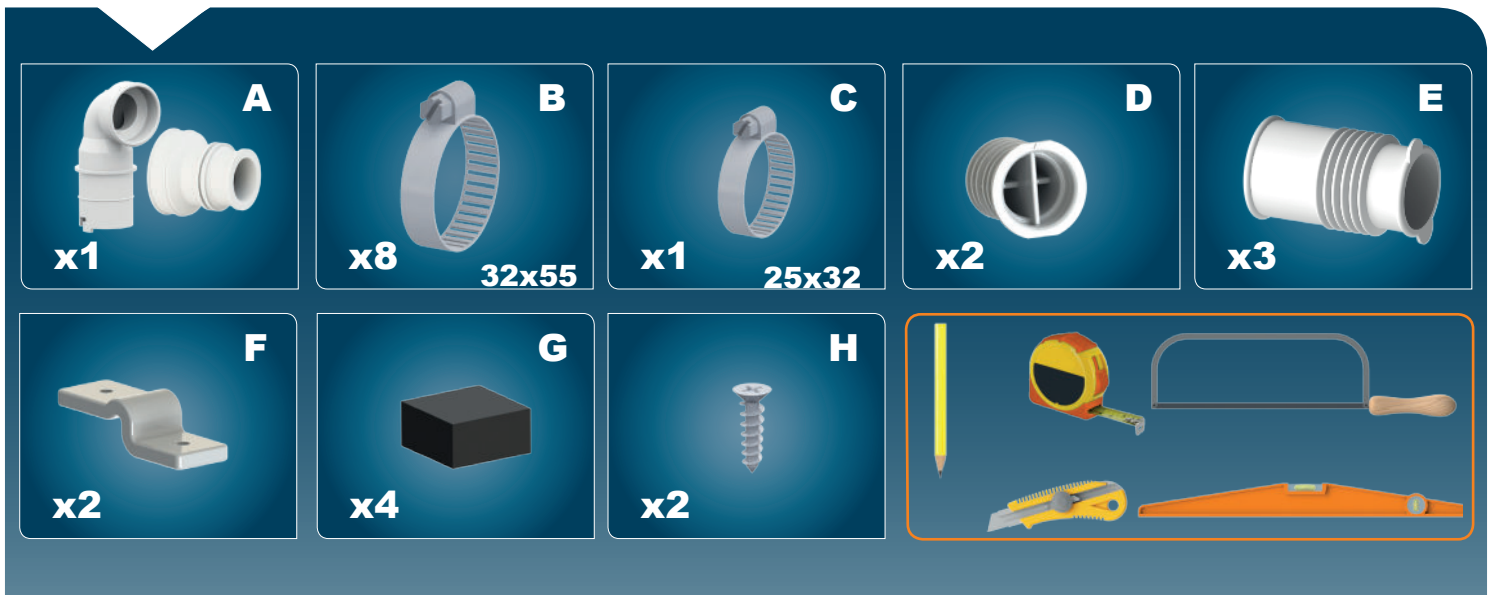

4



5

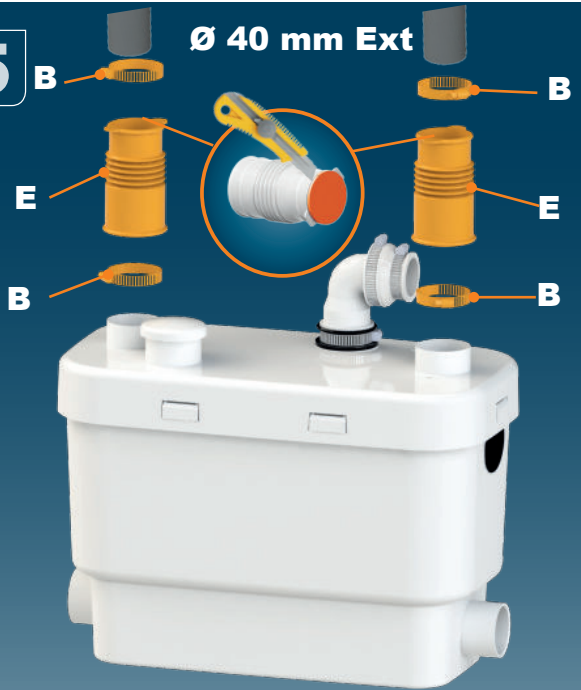

6

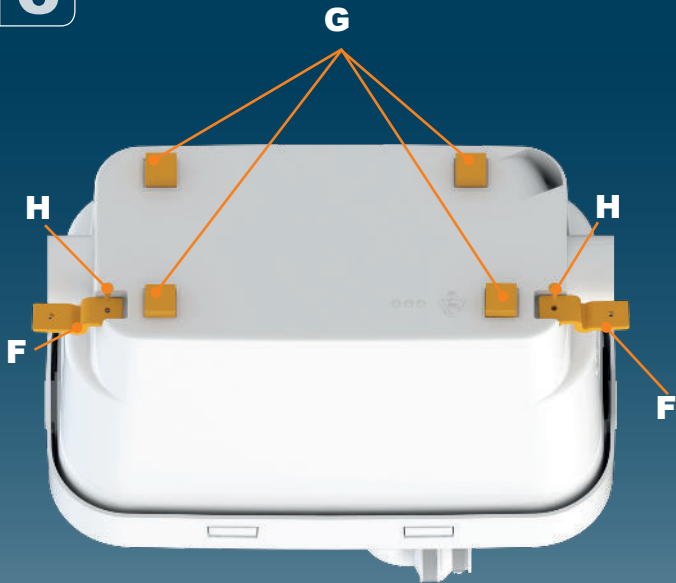

7

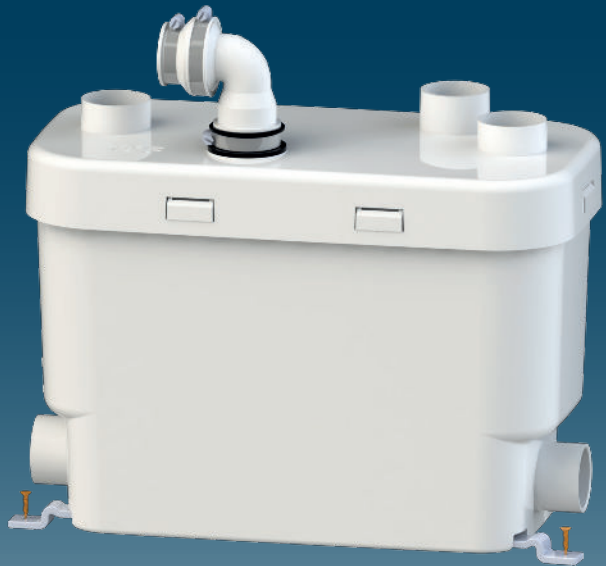

8

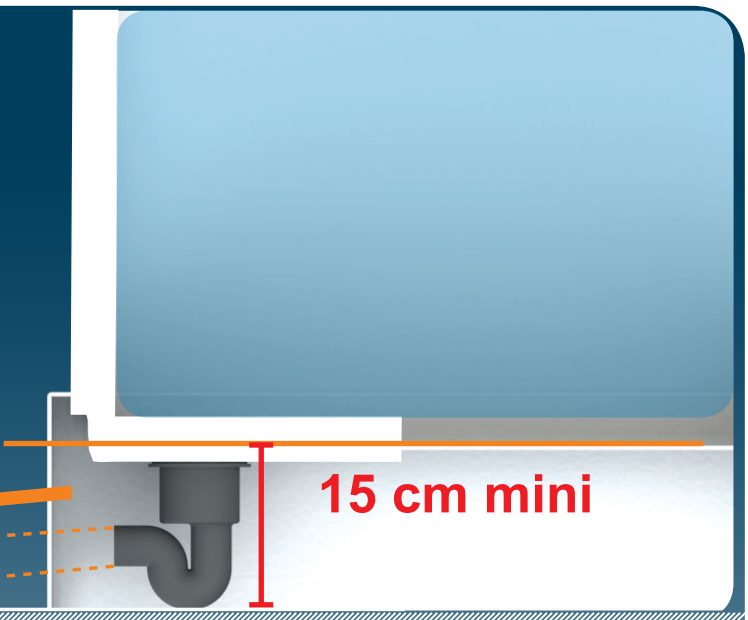

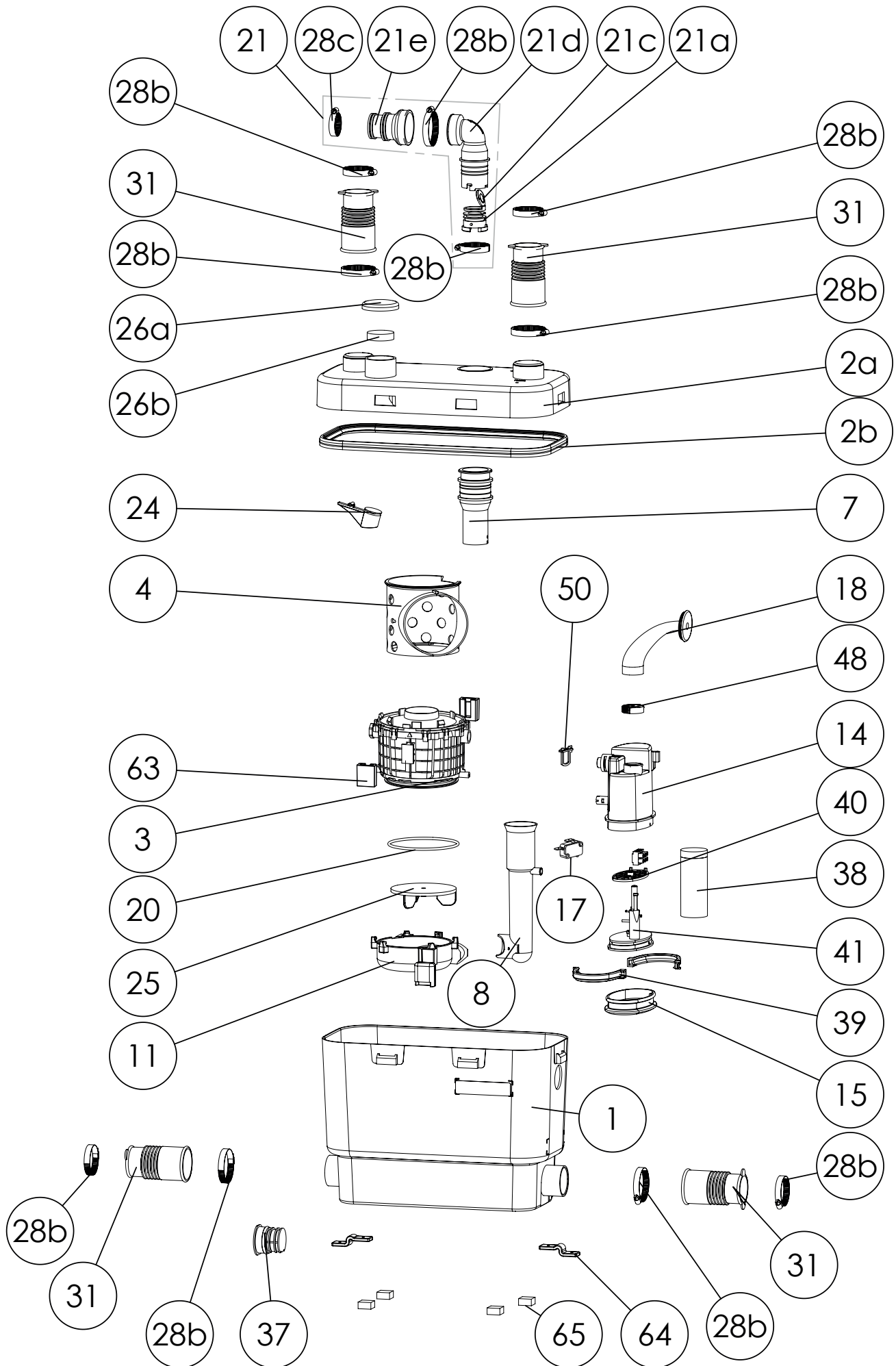

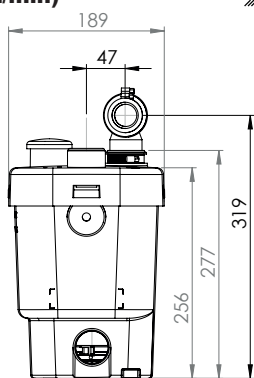
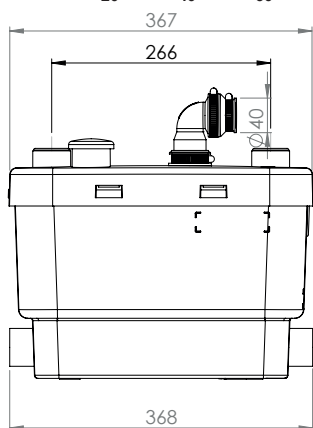
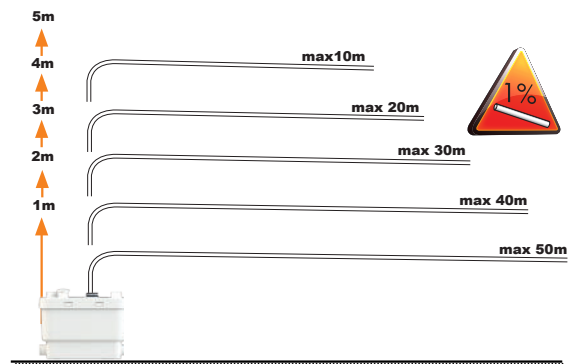
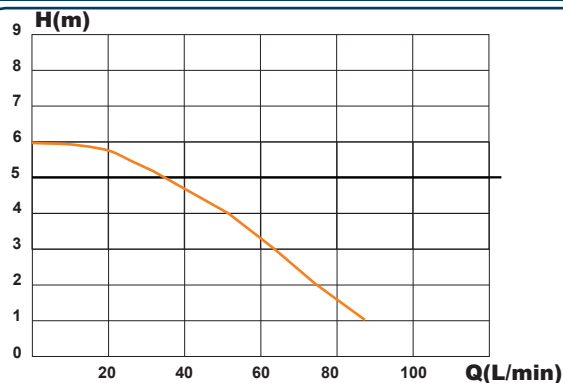

## SANIVITE/SANIPUMP 2

**V35**  
**EN 12050-2**  
**H<sub>max</sub> (Q=0)=6m**  
**MAX 60 °C (5 min)**  
**220-240 V - 50/60 Hz**  
**400 W - 1,7 A - IP44 - ⚡**  
**6,4 KG**

### FRANCE

**SOCIÉTÉ FRANÇAISE  
D'ASSAINISSEMENT**  
41 bis avenue Bosquet - 75007 Paris  
Tél. +33 1 44 82 39 00  
Fax +33 1 44 82 39 01

### UNITED KINGDOM

**SANIFLO Ltd.,**  
Howard House, The Runway  
South Ruislip Middx.,  
HA4 6 SE  
Tel. +44 208 842 0033  
Fax +44 208 842 1671

### IRELAND

**SANIRISH Ltd**  
IDA Industrial Estate  
Edenderry - County Offaly  
Tel. + 353 46 9733 102  
Fax + 353 46 97 33 093

### AUSTRALIA

**SANIFLO (Australasia) Pty Ltd**  
Unit 9/10, 25 Gibbes Street  
Chatswood NSW 2067  
Tel. +61 298 826 200  
Fax +61 298 826 950

### DEUTSCHLAND

**SFA SANIBROY GmbH**  
Waldstr. 23 Geb. B5 - 63128  
Dietzenbach  
Tel. (060 74) 30928-0  
Fax (060 74) 30928-90

### ITALIA

**SFA ITALIA spa**  
Via del Benessere, 9  
27010 Siziano (PV)  
Tel. 03 82 61 81  
Fax 03 82 61 8200

### ESPAÑA

**SFA S.L.**  
C/ Vinyalets, 1 - P.I. Can Vinyalets  
08130 Sta. - Perpètua de Mogoda -  
Barcelona  
Tel. +34 93 544 60 76  
Fax +34 93 462 18 96

### PORTUGAL

**SFA, Lda.**  
Sintra Business Park, ed.01-  
1ºP2710-089 SINTRA  
Tel. +35 21 911 27 85  
Fax +35 21 957 70 00

### РОССИЯ

**SFA РОССИЯ**  
101000 Москва - Колпачный переулок 9а  
Тел. (495) 258 29 51  
Факс. (495) 258 29 51

### SUISSE SCHWEIZ SVIZZERA

**SFA SANIBROY AG**  
Vorstadt 4  
3380 Wangen a. A.  
Tel. + 41 (0)32 631 04 74  
Fax + 41 (0)32 631 04 75

### BENELUX

**SFA BENELUX B.V.**  
Voitaweg 4  
6101 XK Echt (NL)  
Tel. +31 475 487100  
Fax +31 475 486515

### SVERIGE

**SANIFLO AB**  
BOX 797  
S-191 27 Sollentuna  
Tel. +46 (0)8-404 15 30  
info@saniflo.se

### POLSKA

**SFA POLAND Sp. z o.o.**  
ul. Białolecka 168  
03-253 Warszawa  
Tel. (+4822) 732 00 32  
Fax (+4822) 751 35 16

### ČESKÁ REPUBLIKA

**SFA-SANIBROY, spol. s r.o**  
Na Košince č.ev. 681- 180 00 PRAHA8 -  
Libeň  
Tel. +420 266 712 855  
Fax , +420 266 712 856

### ROMANIA

**SFA SANIFLO S.R.L.**  
145B Foișorului Street District 3  
31177 BUCUREȘTI  
Tel. +40 256 245 092  
Fax +40 256 245 029

### TÜRKIYE

**SFA SANIHYDRO LTD STI**  
Mecidiye Cad No:36-B Sevanca APT  
34394 MECIDIYEKÖY - İSTANBUL  
Tel. +90 212 275 30 88  
Fax , +90 212 275 90 58

### CHINA

**SFA 中国**  
上海市静安区石门二路333弄3号振安  
广场恒安大厦27C (200041 )  
Tel. +86(0)21 6218 8969  
Fax. +86(0)21 6218 8970

### KOREA

**www.SFA.biz**  
sales@saniflo-korea.kr

### South Africa

**Saniflo Africa (PTY) Ltd**  
Unit A6 , Spearhead Business Park  
Cnr. Freedom Way & Montague Drive  
Montague Gardens, 7441  
Tél : +27 (0) 21 286 00 28  
info@saniflo.co.za

### BRAZIL

**SFA Brasil Equipamentos Sanitários,**  
Rua Maria Figueiredo 595  
CEP 04002-003 SAO PAULO / SP  
Tel. (11) 3052-2292  
www.sanitrit.com.br

## SERVICE HELPLINES

	TEL	FAX			
France	01 44 82 25 55	03 44 94 46 19	Benelux	+31 475 487100	+31 475 486515
United Kingdom	08457 650011 (Call from a land line)	020 8842 1671	Sverige	+46 (0)8-404 15 30	
Ireland	1850 23 24 25 (LOW CALL)	+ 353 46 97 33093	Norge	+46 (0)8-404 15 30	
Australia	+1300 554 779	+61.2.9882.6950	Polka	(+4822) 732 00 33	(+4822) 751 35 16
Deutschland	0800 82 27 82 0	(060 74) 30928-90	РОССИЯ	(495) 258 29 51	(495) 258 29 51
Italia	0382 6181	+39 0382 618200	Česká Republika	+420 266 712 855	+420 266 712 856
España	+34 93 544 60 76	+34 93 462 18 96	România	+40 256 245 092	+40 256 245 029
Portugal	+35 21 911 27 85	+35 21 957 70 00	Türkiye	+90 212 275 30 88	+90 212 275 90 58
Suisse Schweiz Svizzera	+41 (0)32 631 04 74	+41 (0)32 631 04 75	中国	+86(0)21 6218 8969	+86(0)21 6218 8970
			Brazil	(11) 3052-2292	

Service information : [www.sfa.biz](http://www.sfa.biz)