

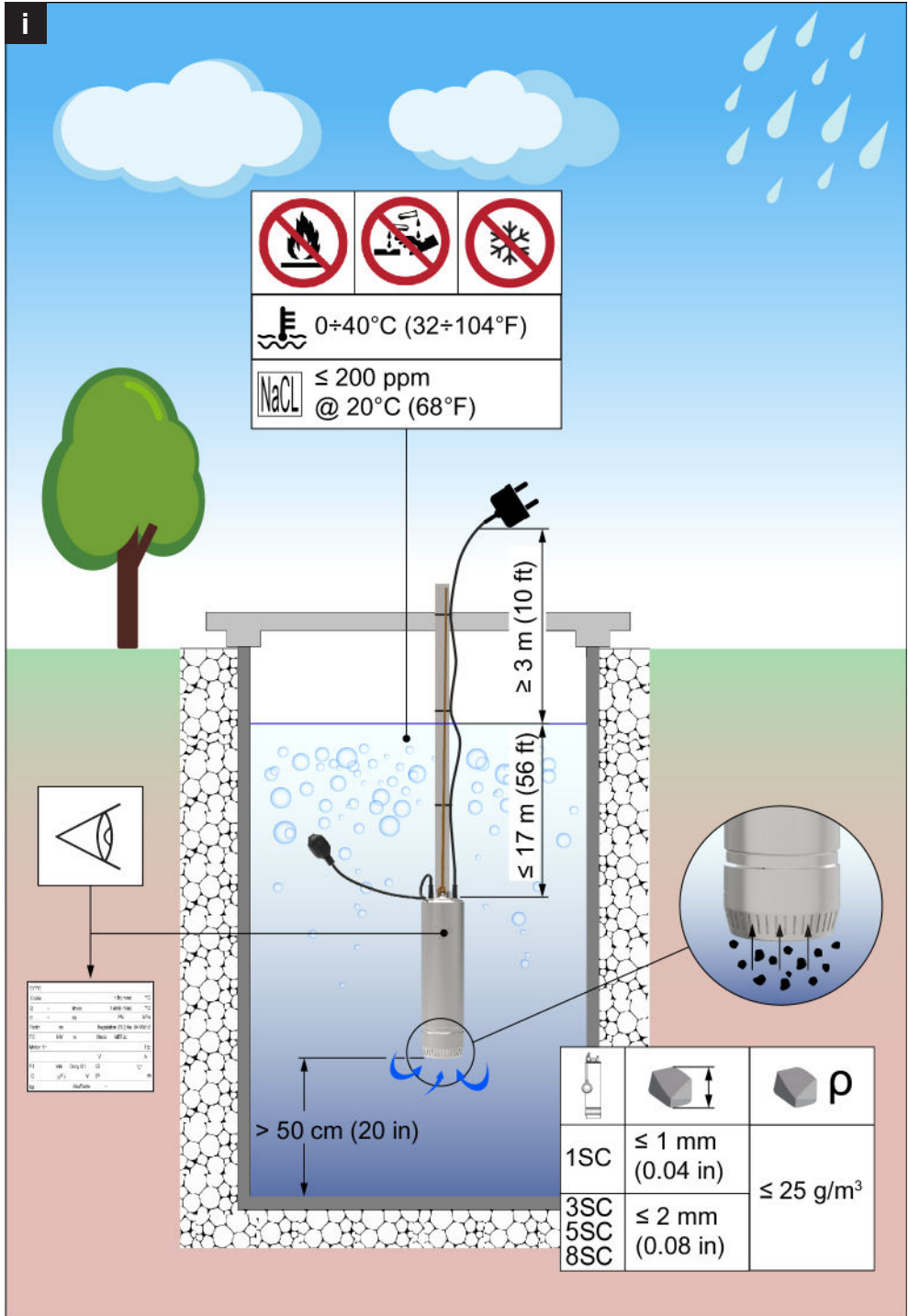

Quick Startup Guide



SCUBA Series



$0 \div 40^{\circ}\text{C} \quad (32 \div 104^{\circ}\text{F})$		
$\text{NaCl} \leq 200 \text{ ppm}$ $@ 20^{\circ}\text{C} \quad (68^{\circ}\text{F})$		

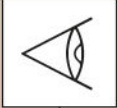

Code	1000000
Color	White
Material	PP
Weight	1.5 kg
Dimensions	1000 x 1000 x 1000 mm
Manufacturer	...
Notes	...

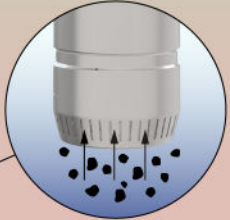

		ρ
1SC	$\leq 1 \text{ mm}$ (0.04 in)	$\leq 25 \text{ g/m}^3$
3SC	$\leq 2 \text{ mm}$ (0.08 in)	
5SC		
8SC		

1a

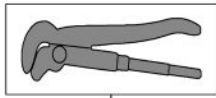

1b

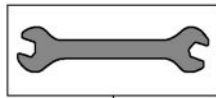

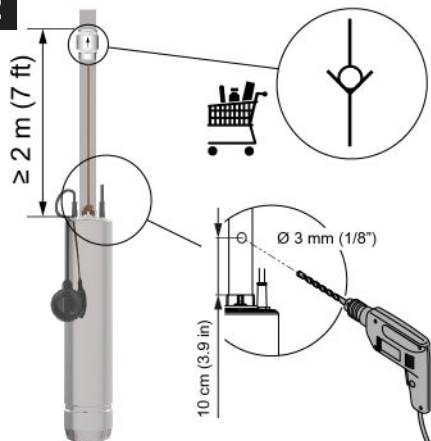
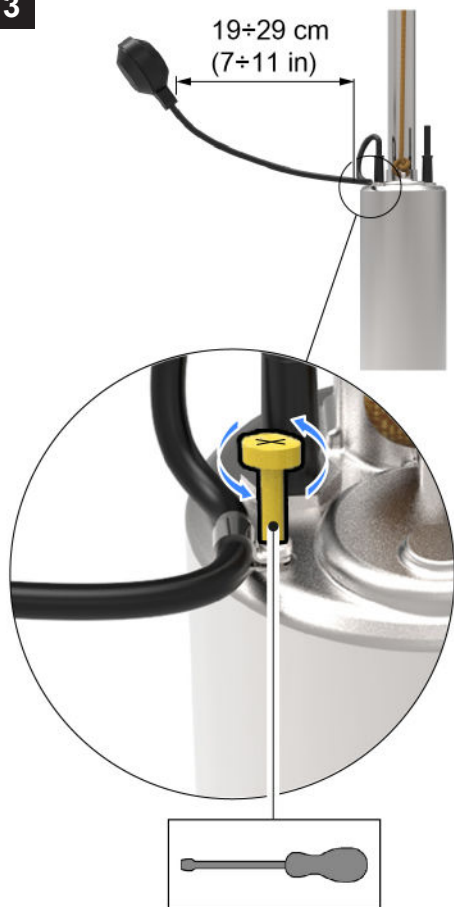
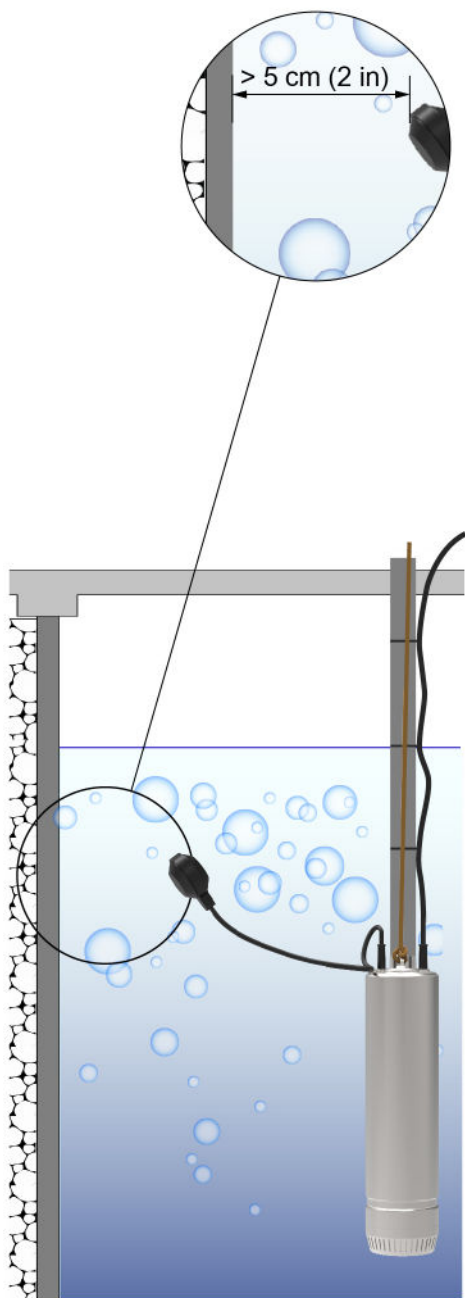
2**3****i**

i

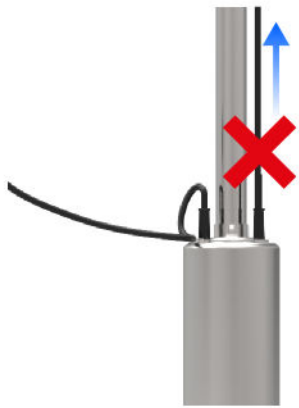
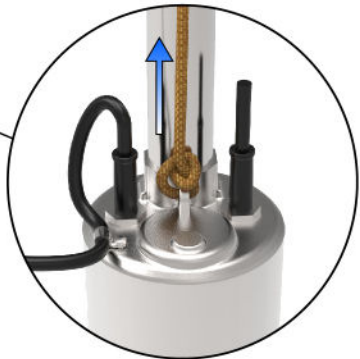
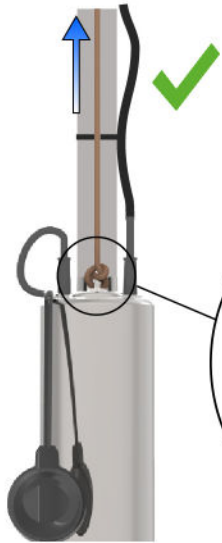

i

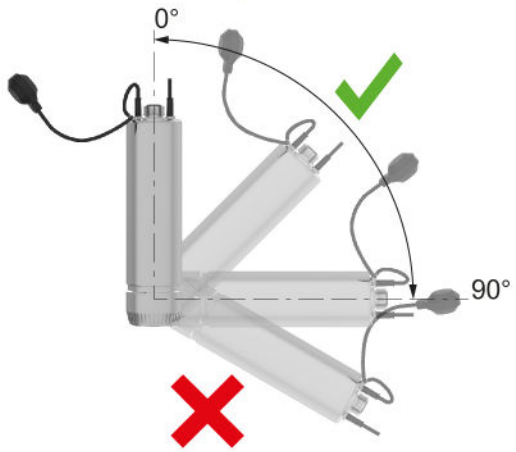

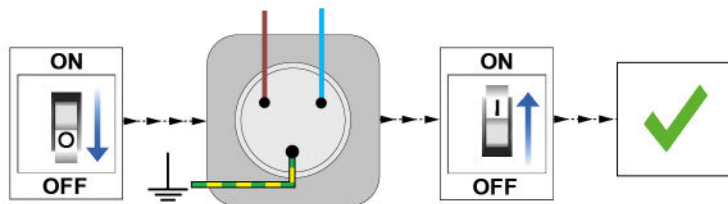
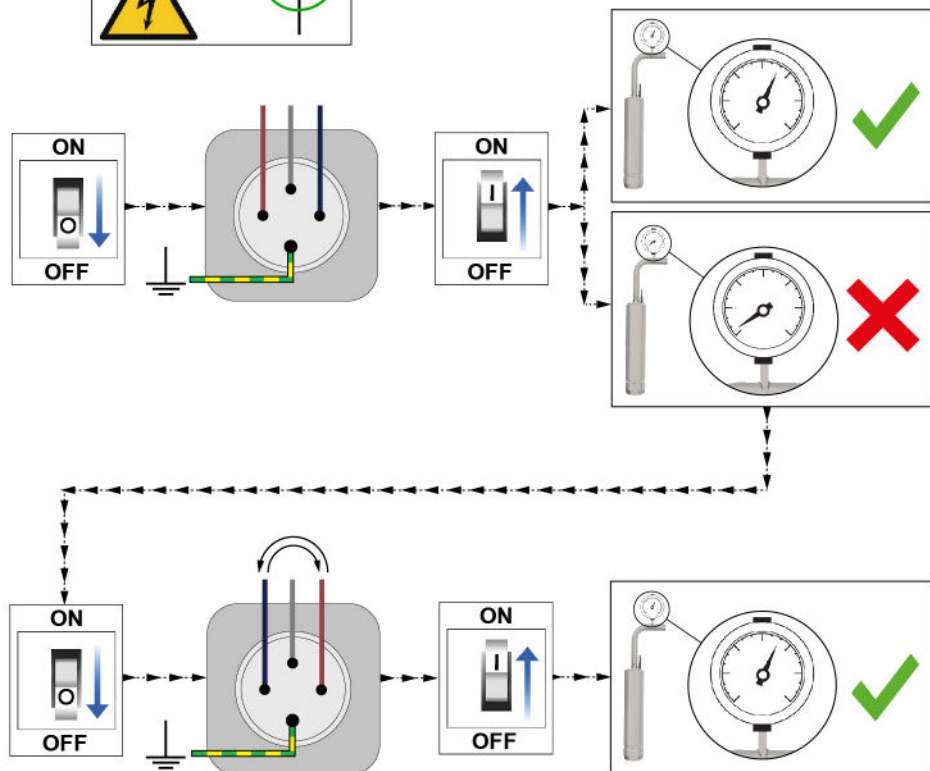
4a**4b**



<http://lowara.com/pumps-circulators/submersible-borehole-pumps/scuba-close-coupled-submersible-pumps/#product-tab-literature>

Xylem |'zīləm|



Xylem Service Italia S.r.l.
Via Vittorio Lombardi 14
Montecchio Maggiore (VI) 36075
Italy

© 2018 Xylem, Inc.

Cod.001082028 rev.B ed.03/2019