

# JP / JP PM JP PT-V / JP PT-H



Further product documentation  
[net.grundfos.com/qr/i/99520338](http://net.grundfos.com/qr/i/99520338)

be  
think  
innovate

**GRUNDFOS** 

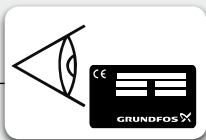

Min./Max. 0/40 °C (S3: 60 °C)  
Min./Max. 32/104 °F (S3: 140 °F)



$P_{max} = 6 \text{ bar (87 psi)}$



• Voltage [V]      • Connection:  
• Frequency [Hz]      GAS / NPT

Min./Max. 0/40 °C (S3: 55 °C)  
Min./Max. 32/104 °F (S3: 131 °F)



JP



JP

Max. 8 m / 26 ft

$\geq 0.5$  m / 1.64 ft

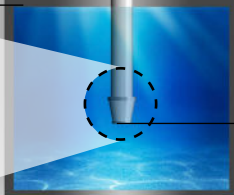
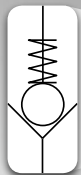
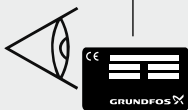
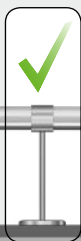
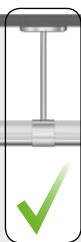

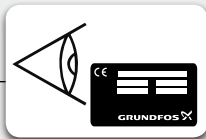

Min./Max. 0/40 °C (S3: 60 °C)  
Min./Max. 32/104 °F (S3: 140 °F)



$P_{max} = 6 \text{ bar (87 psi)}$



- Voltage [V]
- Frequency [Hz]
- Connection: GAS / NPT

Min./Max. 0/40 °C (S3: 55 °C)  
Min./Max. 32/104 °F (S3: 131 °F)



JP PM



$P_{start} = 1.5 \text{ bar (22 psi)}$

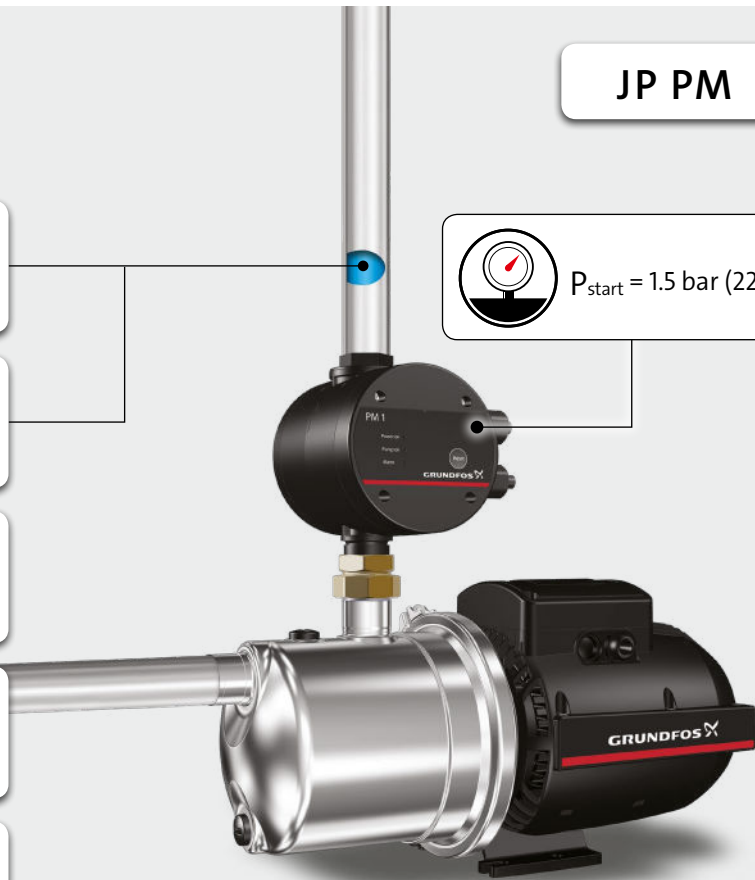

JP PM

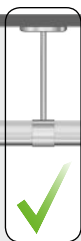

Max. 10 m



Max. 8 m / 26 ft

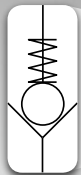

$\geq 0.5$  m / 1.64 ft

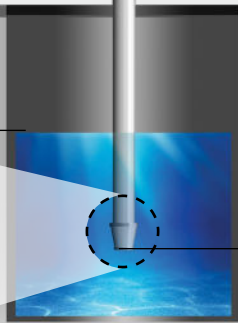

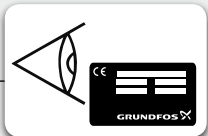

Min./Max. 0/40 °C (S3: 60 °C)  
Min./Max. 32/104 °F (S3: 140 °F)



$P_{max} = 6 \text{ bar (87 psi)}$



• Voltage [V]      • Connection:  
• Frequency [Hz]      GAS

Min./Max. 0/40 °C (S3: 55 °C)  
Min./Max. 32/104 °F (S3: 131 °F)



JP PT-V

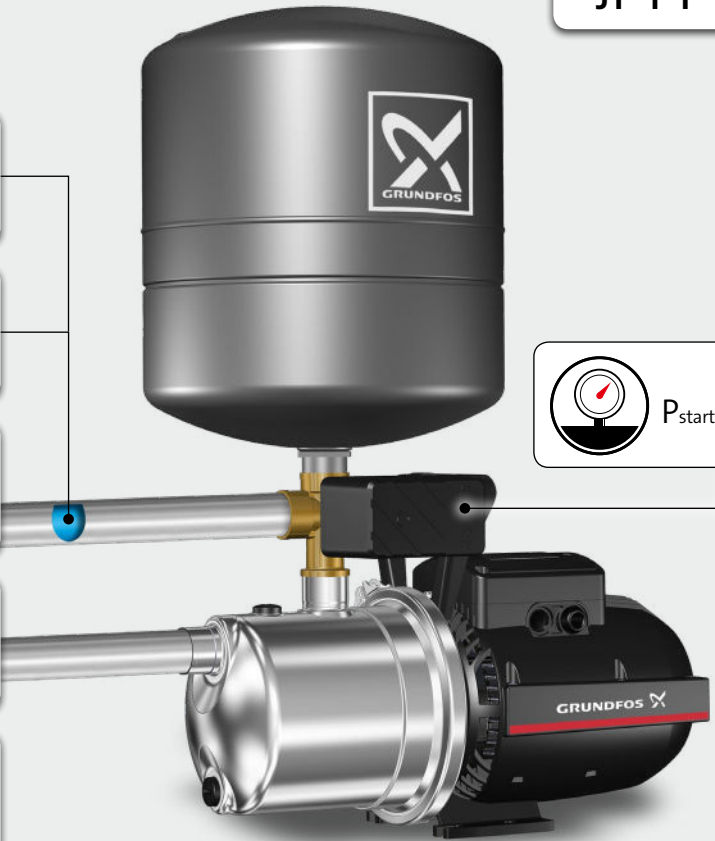

$P_{start} = 2.2 \text{ bar}$

JP PT-V

(32 psi)

Max. 8 m / 26 ft

$\geq 0.5 \text{ m} / 1.64 \text{ ft}$

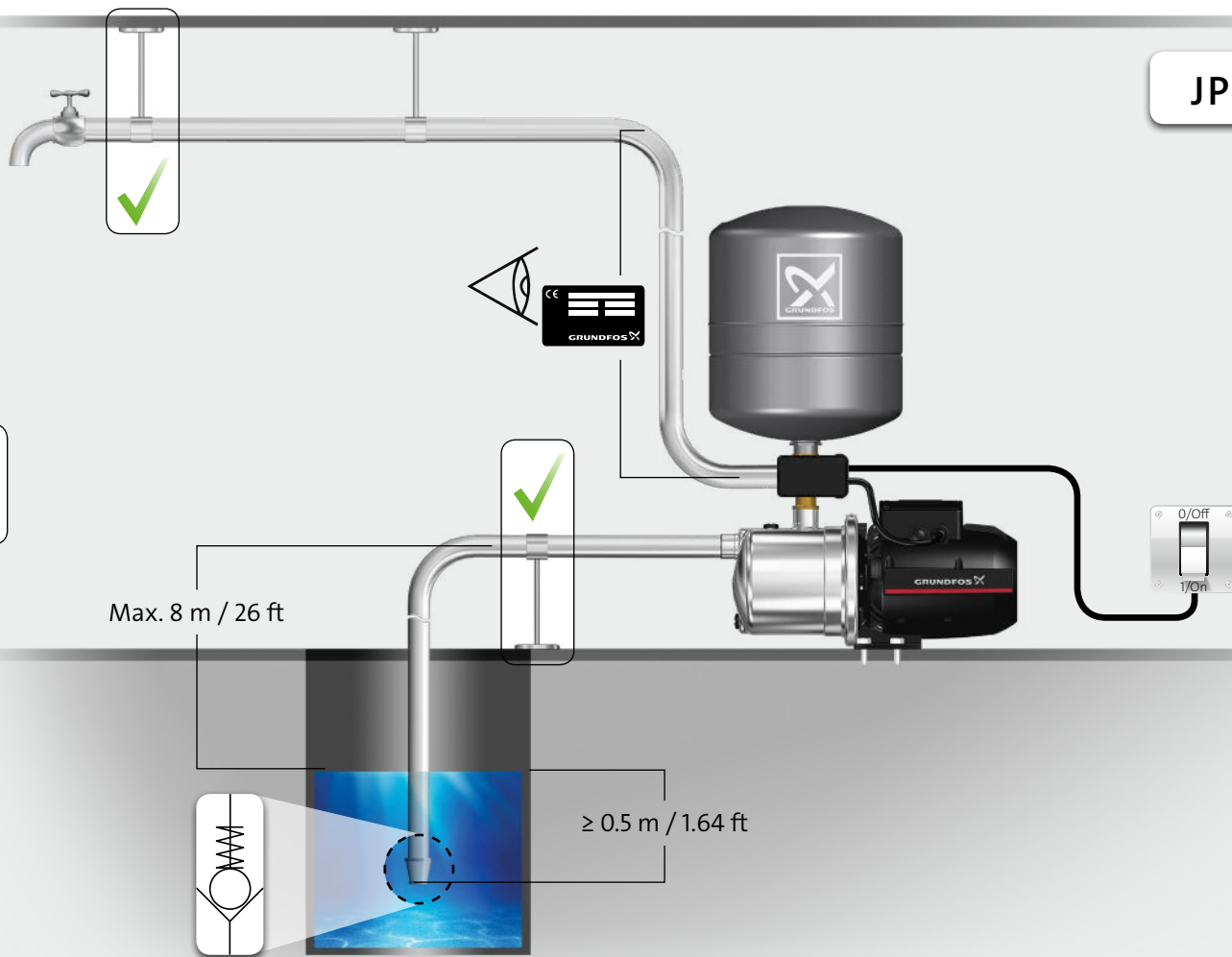

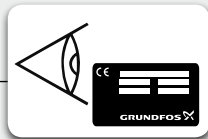

Min./Max. 0/40 °C (S3: 60 °C)  
Min./Max. 32/104 °F (S3: 140 °F)



$P_{max} = 6 \text{ bar (87 psi)}$



• Voltage [V]      • Connection:  
• Frequency [Hz]      GAS

Min./Max. 0/40 °C (S3: 55 °C)  
Min./Max. 32/104 °F (S3: 131 °F)



JP PT-H



$P_{start} = 2.2 \text{ bar}$

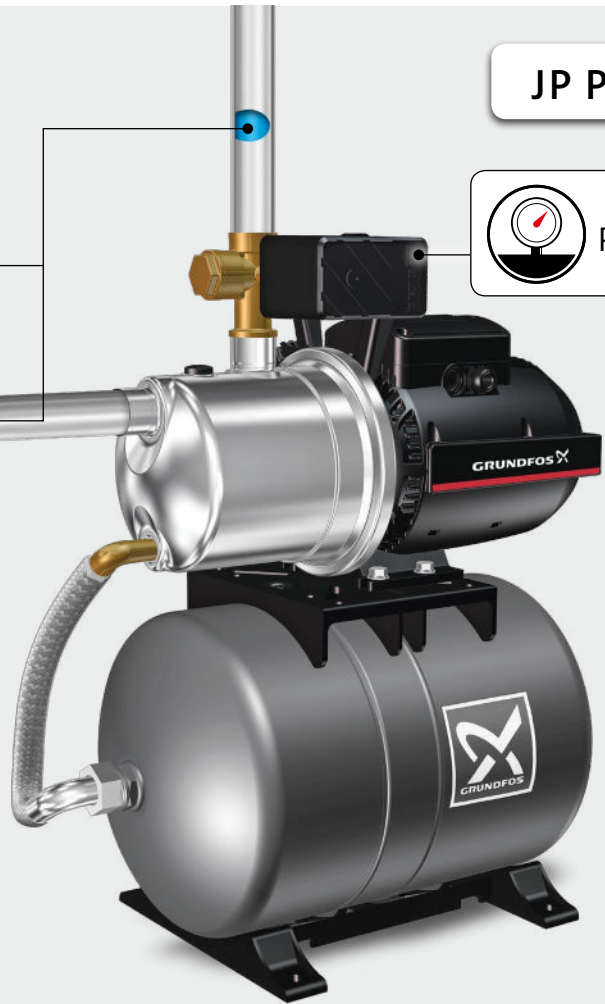



JP PT-H

(32 psi)

Max. 8 m / 26 ft

$\geq 0.5$  m / 1.64 ft

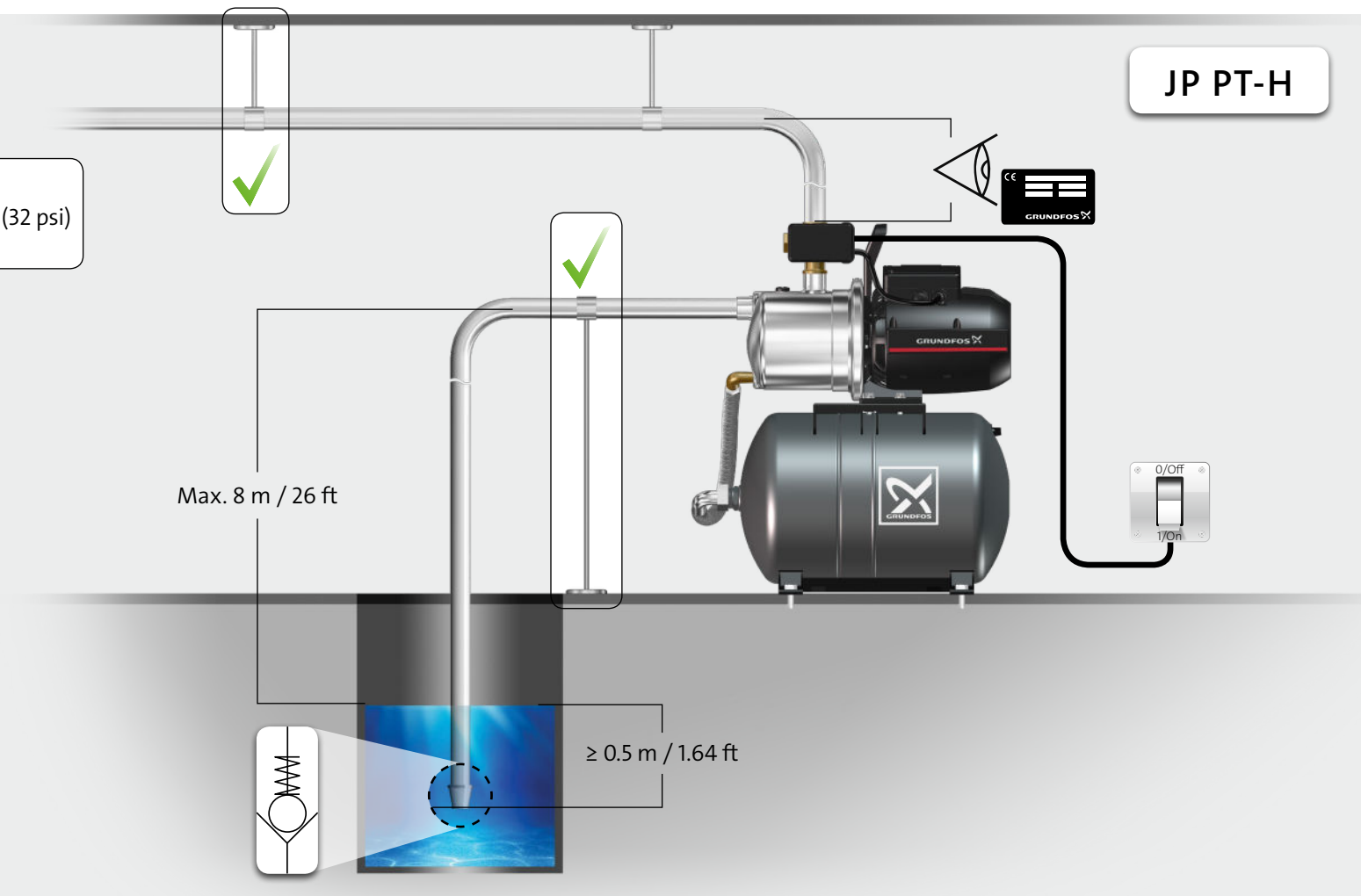

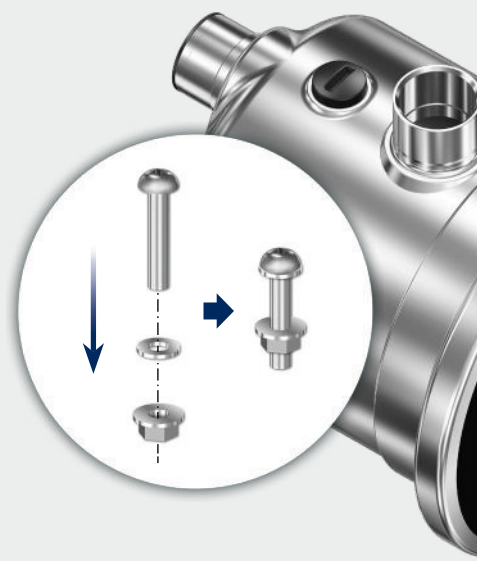
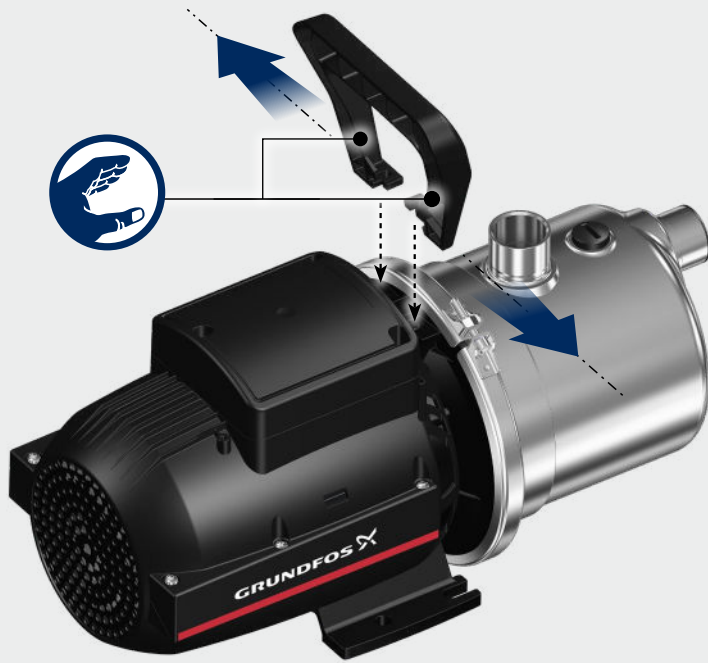
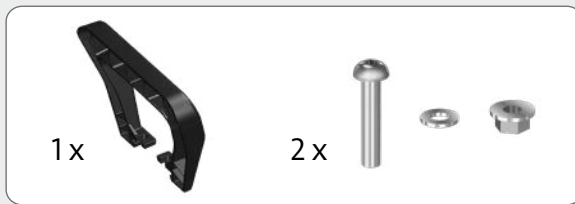

JP



1A

JP / JP PM/ JP

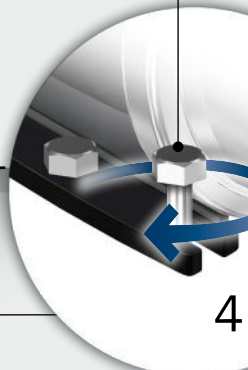
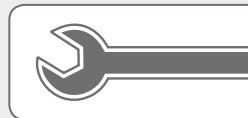
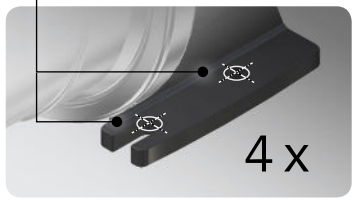
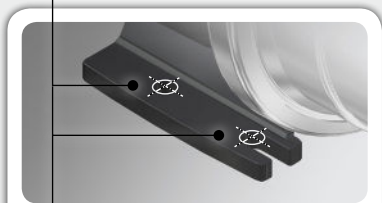
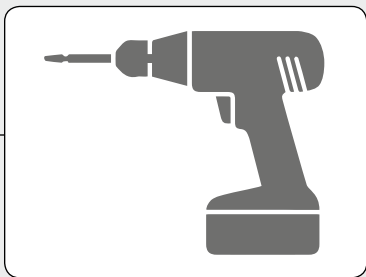

PT-V

1B

JP PT-H

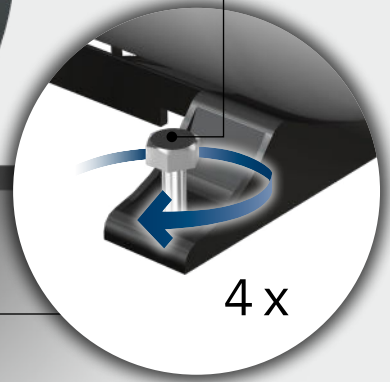
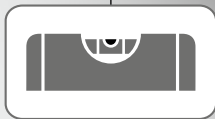
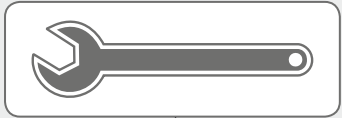



2a

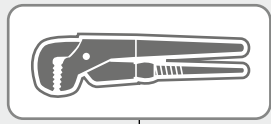
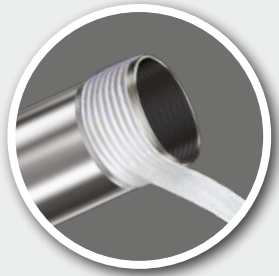

JP

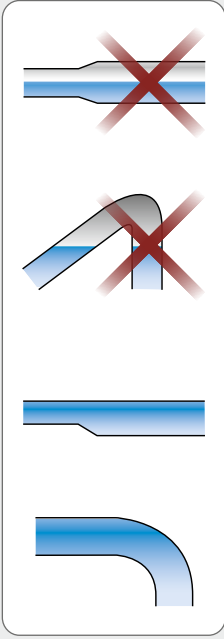

2b

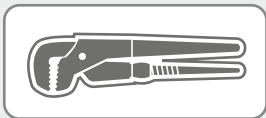
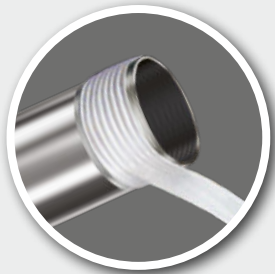

JP PM

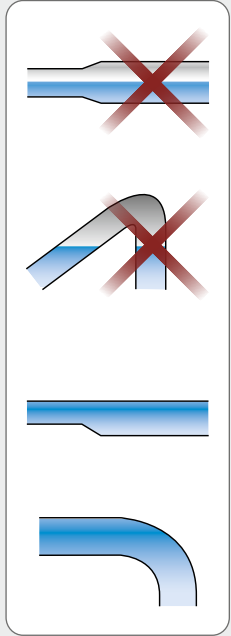

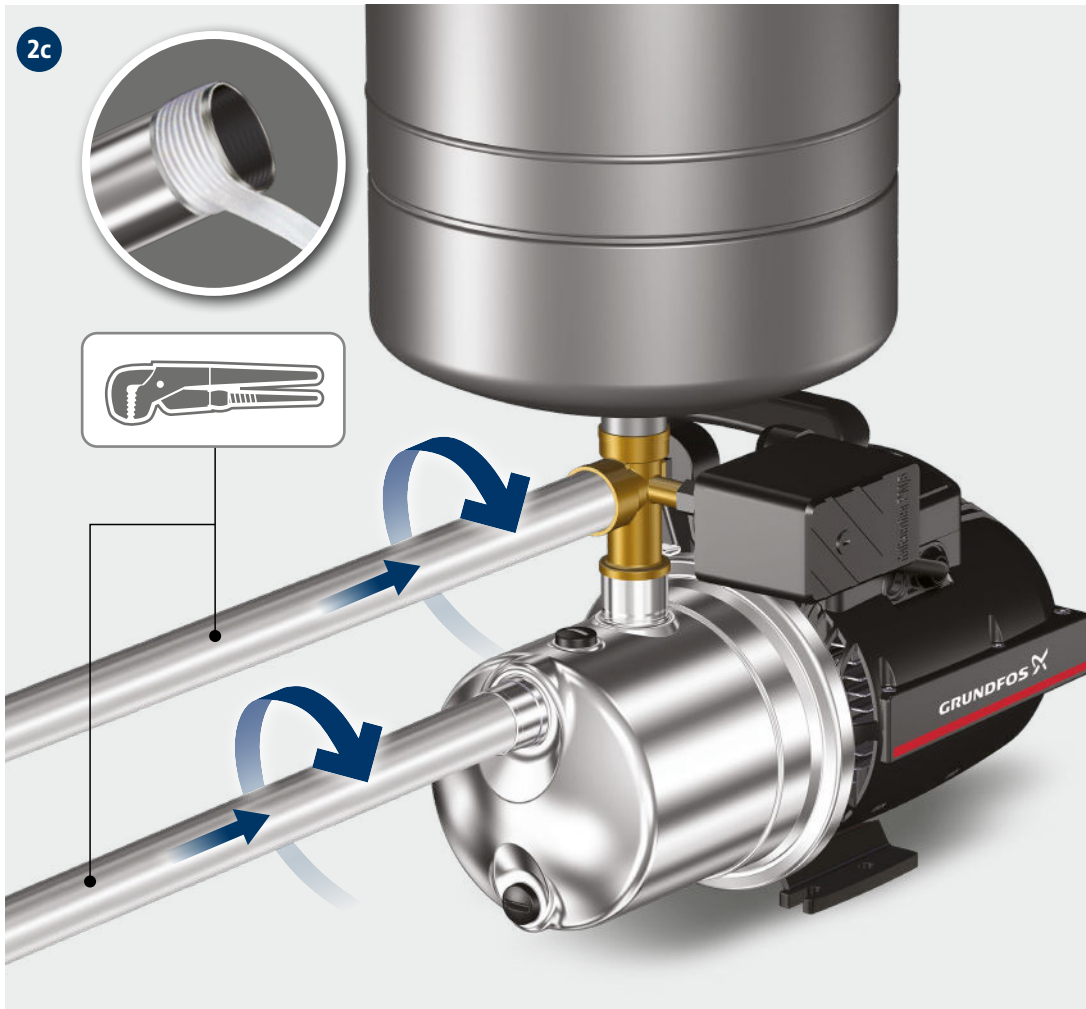

JP PT-V

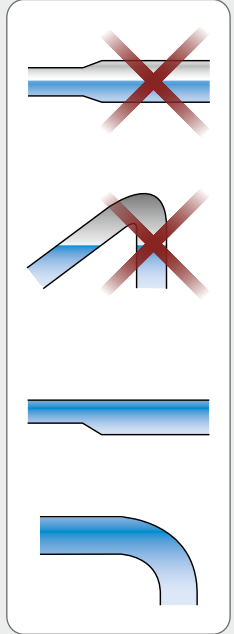



2d

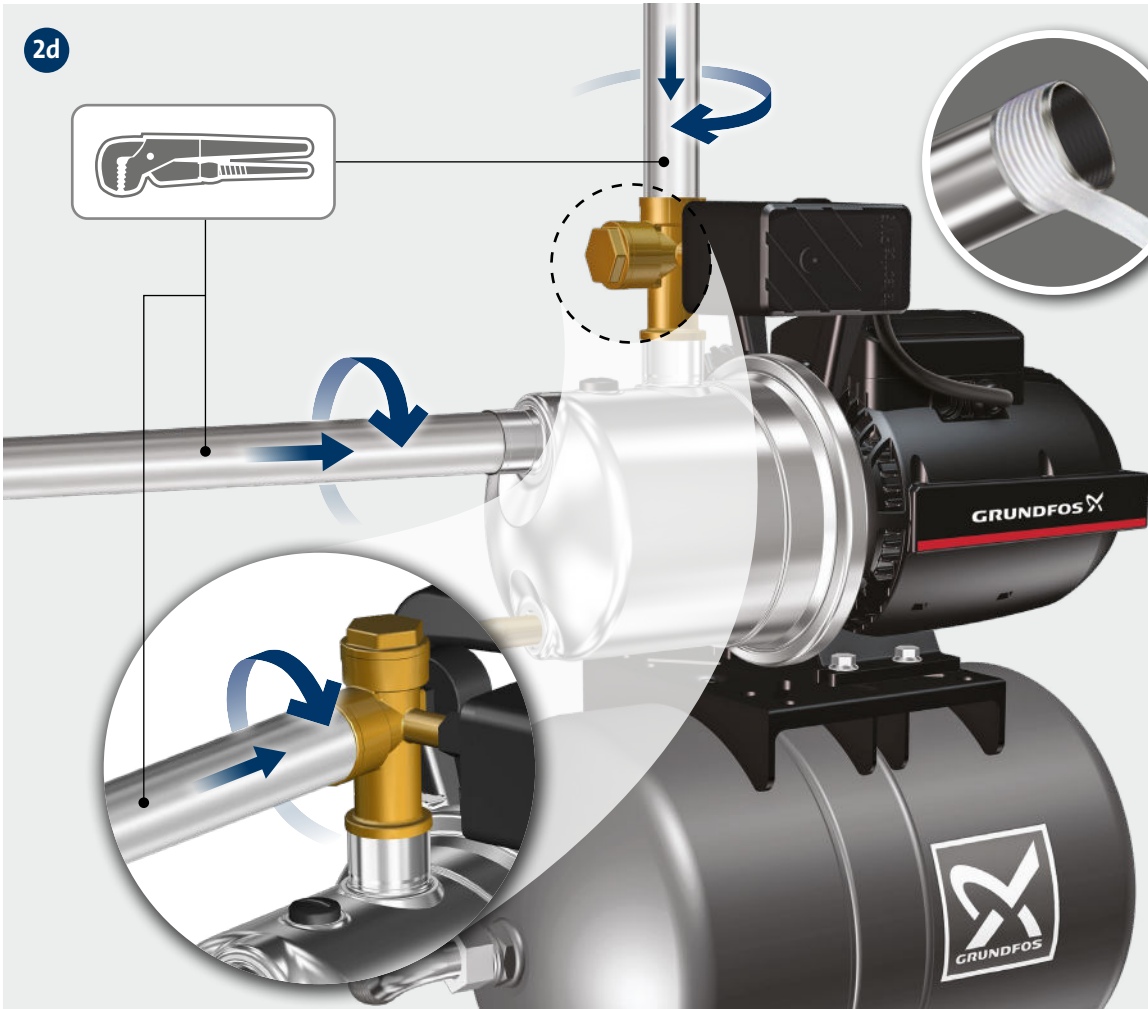
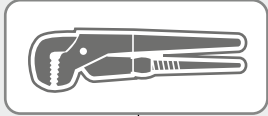

JP PT-H

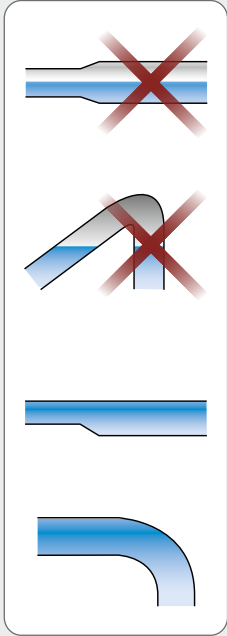



3

JP / JP PM / JP PT-V / JP PT-H

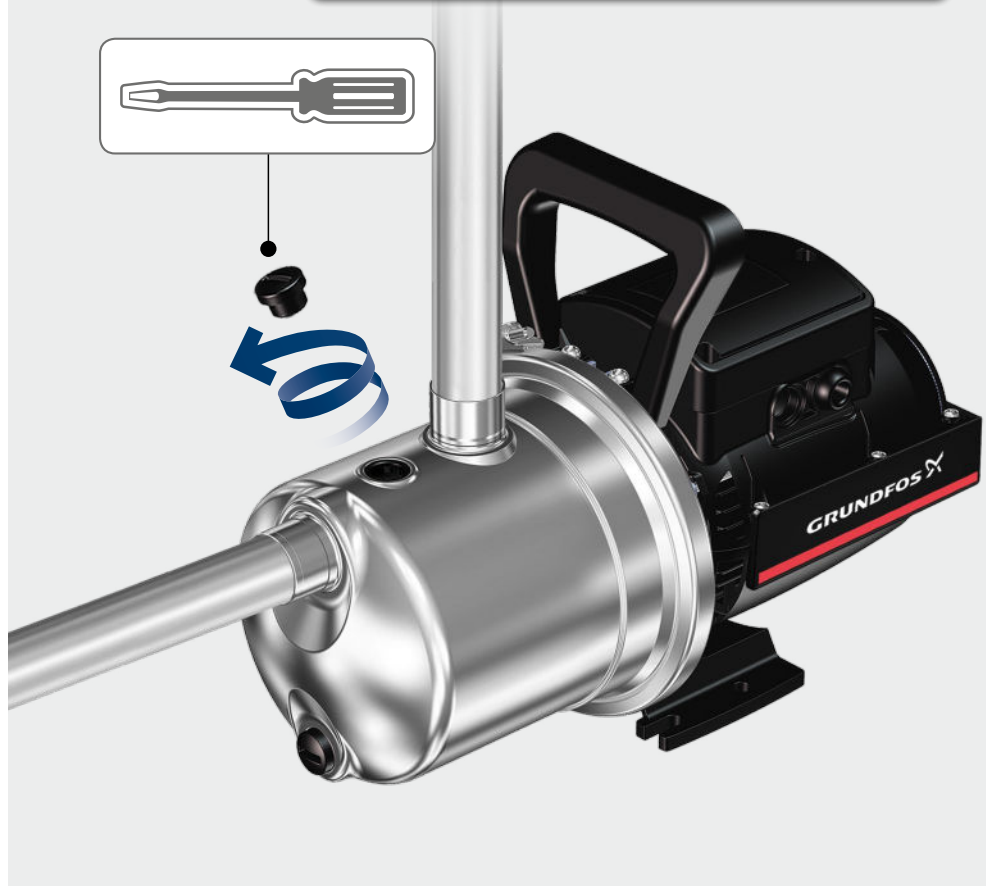
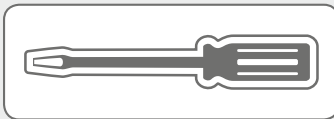

4

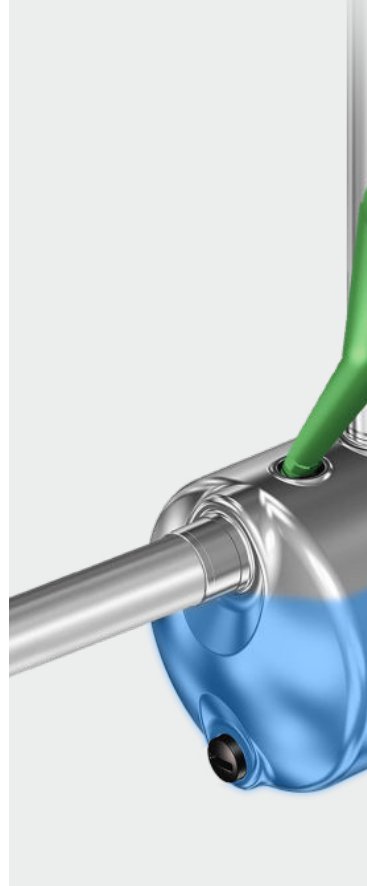



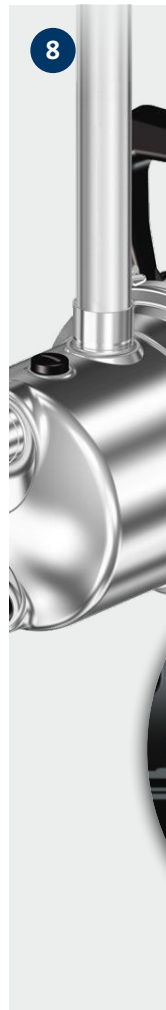
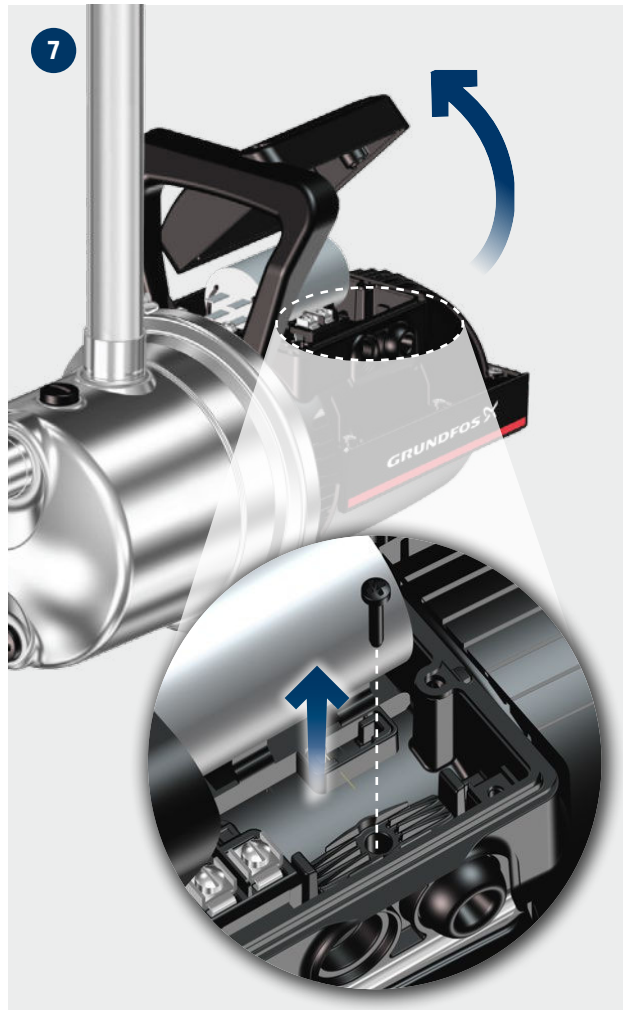

JP / JP PM / JP PT-V / JP PT-H

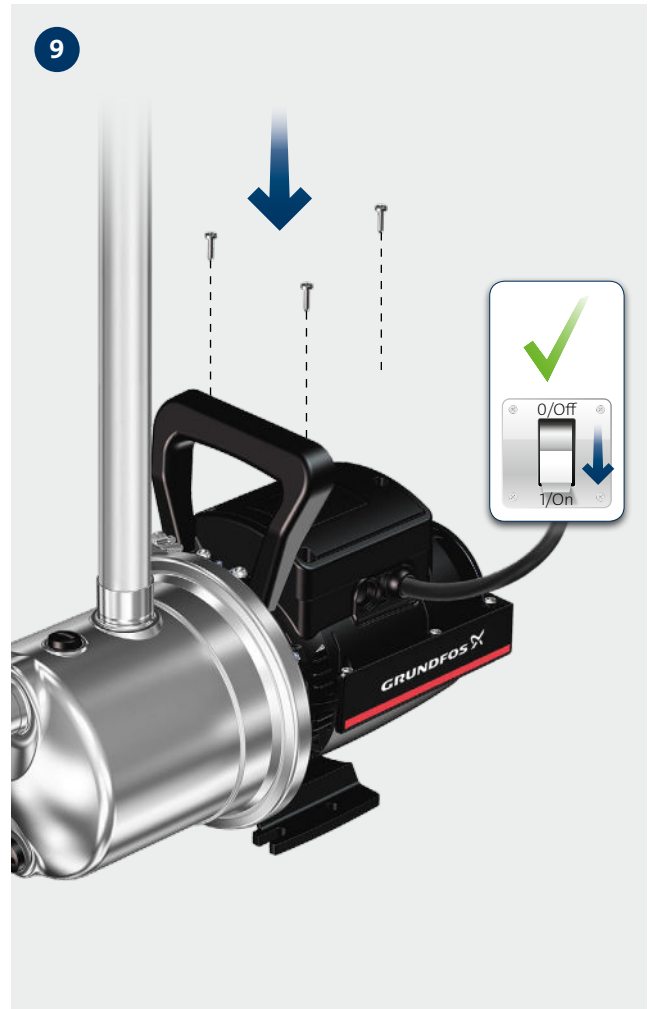

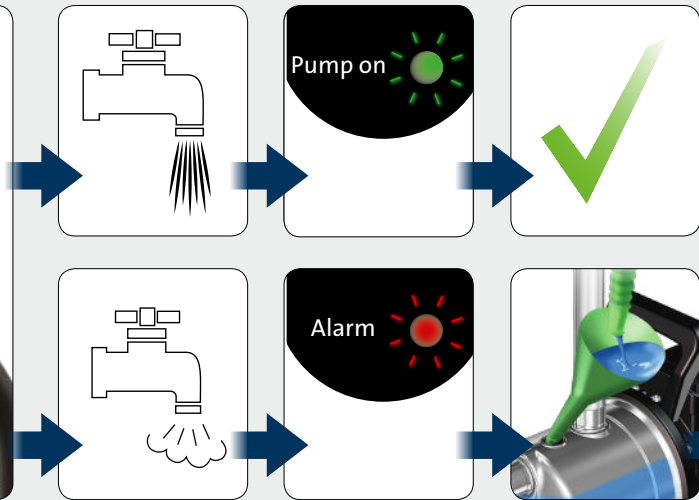

JP PM

Reset



[net.grundfos.com/qr/i/99520338](http://net.grundfos.com/qr/i/99520338)



JP / JP PM / JP PT-V / JP PT-H



be think innovate

Installation date: \_\_\_\_\_

Installer:

---

---

---

---

---

---

99544277 1218

ECM: 1249679

**GRUNDFOS Holding A/S**  
Poul Due Jensens Vej 7  
DK-8850 Bjerringbro  
Tel: +45 87 50 14 00  
[www.grundfos.com](http://www.grundfos.com)

**GRUNDFOS** 

Trademarks displayed in this material, including but not limited to Grundfos, the Grundfos logo and "be think innovate", are registered trademarks owned by The Grundfos Group. All rights reserved.  
© 2018 Grundfos Holding A/S, all rights reserved.