

SP A, SP

Submersible pumps, motors and accessories
50 Hz

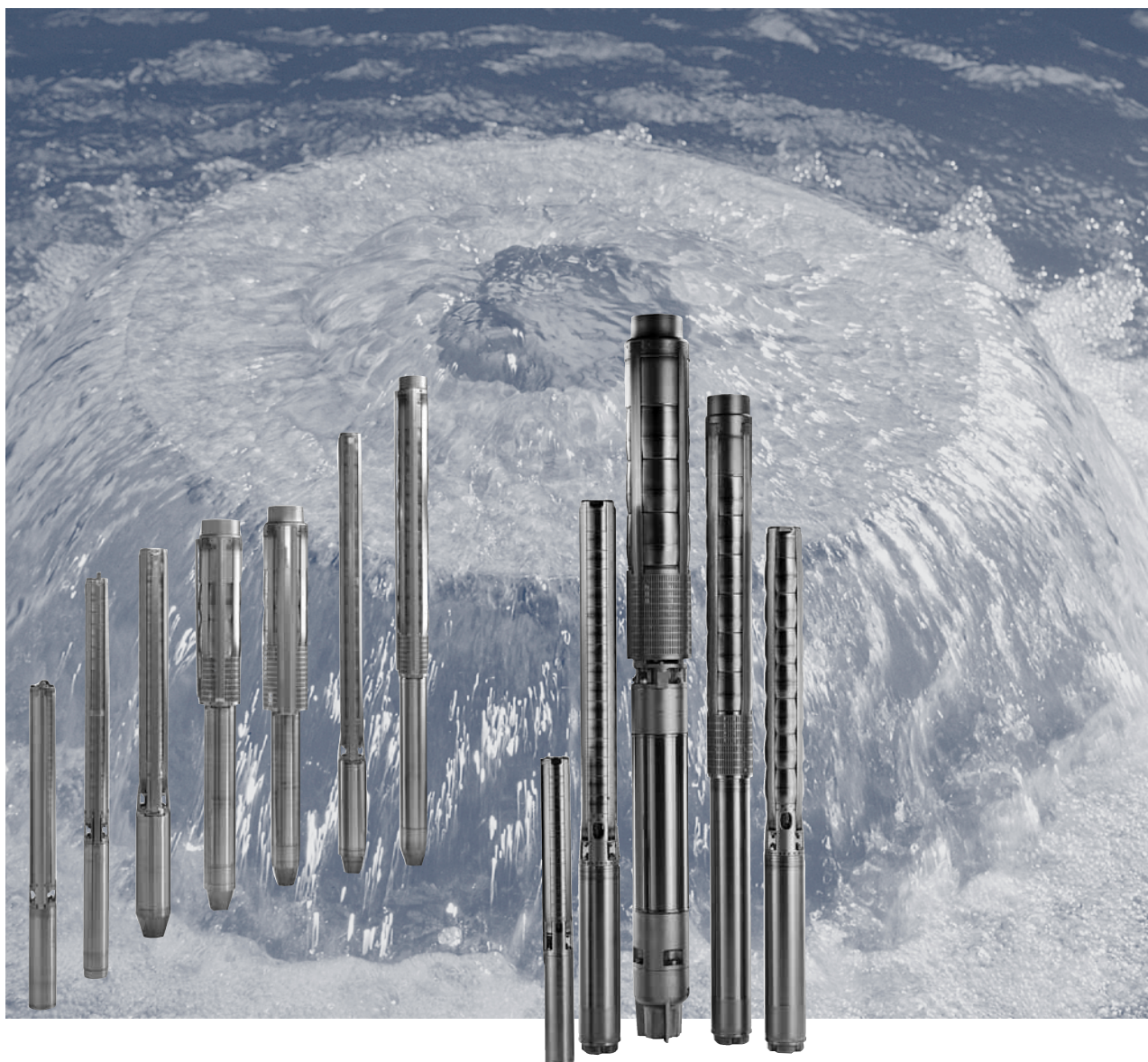

Contents

General data

Performance range	3
Applications	4
Type key	4
Pumped liquids	4
Curve conditions	4
Pump range	5
Motor range	5
Motor protection and controllers	5

Submersible pumps

Features and benefits	6
Material specification	8

Submersible motors

Features and benefits	9
Shaft seal	11
MS 402	11
MS 4000, MS6	11
Material specification for MS motors	12
Material specification for MMS 6000 to 12000 motors	14

Performance curves/ Technical data

SP 1A	16
SP 2A	18
SP 3A	20
SP 5A	22
SP 8A	24
SP 14A	26
SP 17	28
SP 30	33
SP 46	38
SP 60	43
SP 77	48
SP 95	53
SP 125	58
SP 160	63
SP 215	68

Electrical data

1 x 230 V, submersible motors	73
3 x 230 V, submersible motors	73
3 x 230 V, submersible rewindable motors	74
3 x 400 V, submersible motors	74
3 x 400 V, submersible industrial motors	75
3 x 400 V, submersible motors	75
3 x 400 V, submersible rewindable motors	76
3 x 500 V, submersible motors	77
3 x 500 V, submersible industrial motors	77
3 x 500 V, submersible rewindable motors	78

Accessories

CUE frequency converter	79
MP 204 motor protector	82
G100 gateway	85
Connecting pieces	87
Cable termination kit with plug	88
Cable termination kit, type KM	88
Mastik for flat cables	89
Cable termination kit, types M0 to M6	89
Submersible drop cable	90
Zinc anodes	90
Flow sleeves	91
SA-SPM control boxes	91
Capacitors for MS 402B PSC	91
Pt100 sensor	92
Pt1000 sensor	94

Energy consumption

Energy consumption of submersible pumps	96
---	----

Cable sizing

Cables	97
Voltage drop: 1 %	98
Voltage drop: 3 %	99

Table of head losses

Head losses in ordinary water pipes	101
Head losses in plastic pipes	102

Further product documentation

WebCAPS	103
WinCAPS	104

Performance range

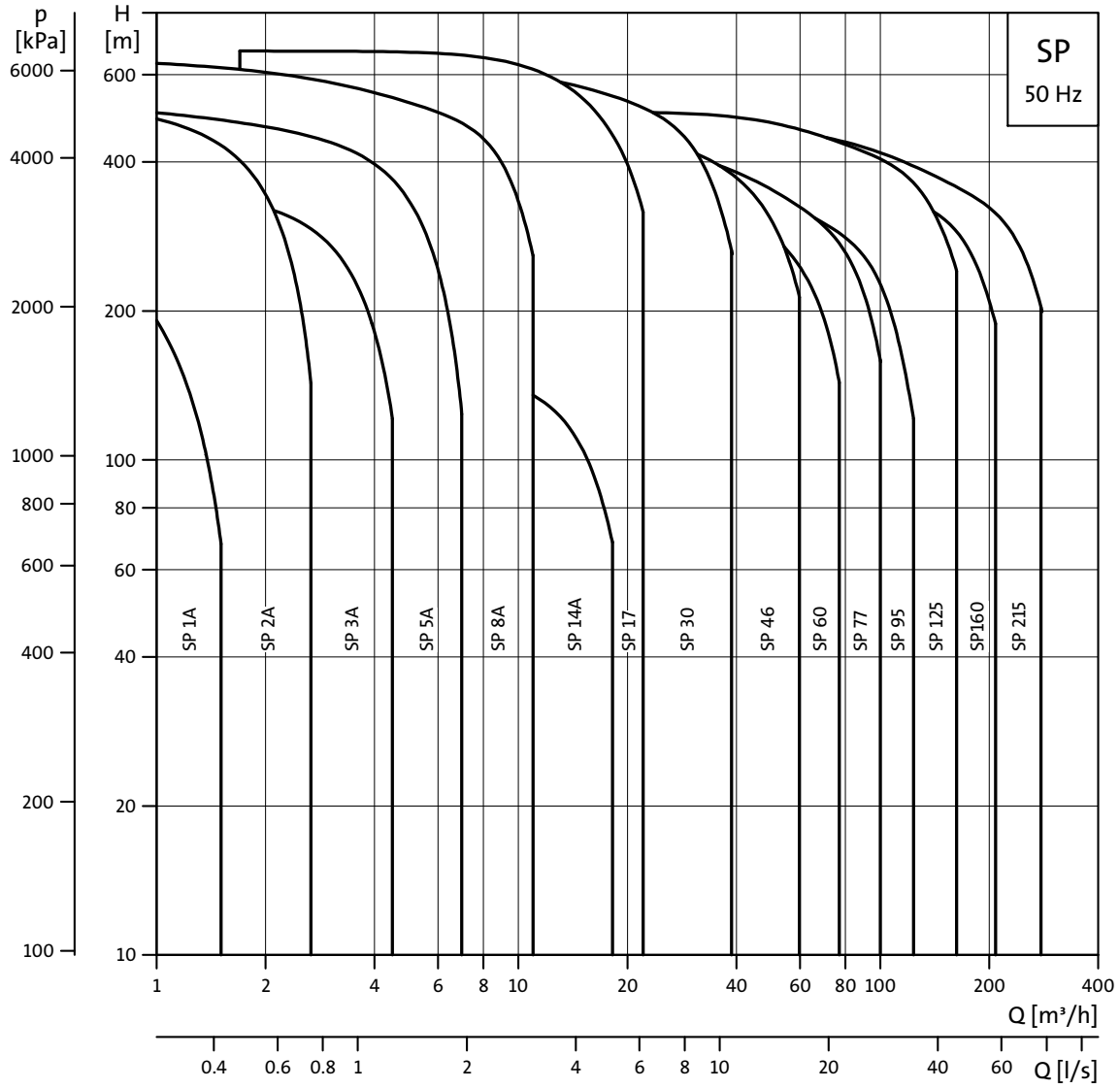

TM00 7254 4702

Applications

The SP A and SP pumps are suitable for the following applications:

- raw-water supply
- irrigation systems
- groundwater lowering
- pressure boosting
- fountain applications
- mining applications
- off-shore applications.

Type key

Example	SP	95	-	5	-	A	B	N
Type range (SP A, SP)								
Rated flow rate in m ³ /h								
Number of impellers								
First reduced-diameter impeller (A, B or C)								
Second reduced-diameter impeller (A, B or C)								
Stainless-steel parts of material = EN 1.4301 N = EN 1.4401 R = EN 1.4539								

Pumped liquids

Clean, thin, non-aggressive liquids without solid particles or fibres.

The special SP A-N and SP-N versions made of stainless steel to EN 1.4401 and SP A-R and SP-R versions made of stainless steel to EN 1.4539 are available for applications involving aggressive liquids.

Maximum liquid temperature

Grundfos motor	Installation		
	Flow velocity past motor [m/s]	Vertical [°C]	Horizontal [°C]
MS 4"	0.15	40	40
MS6 T30 versions	0.15	30	30
MS 4" industrial versions	0.15	60	60
MS6 T60 versions	1.0	60	60
MMS6 with PVC in the windings	0.15	25	25
	0.50	30	30
MMS6 with PE/PA in the windings	0.15	45	45
	0.50	50	50
MMS 6000, 8000, 10000, 12000 rewindable with PVC in the windings	0.15	25	25
	0.50	30	30
MMS 6000, 8000, 10000, 12000 rewindable with PE/PA in the windings	0.15	40	40
	0.50	45	45

Note: For MMS 6000, 37 kW, MMS 8000, 110 kW, and MMS 10000, 170 kW, the maximum liquid temperature is 5 °C lower than the values stated in the table above. For MMS 10000, 190 kW, the temperature is 10 °C lower.

Operating pressure

Grundfos motor	Maximum operating pressure
MS 402	1.5 MPa (15 bar)
MS 4000 and 6"	6 MPa (60 bar)
MMS6, MMS 6000, 8000, 10000, 12000 rewindable	

Curve conditions

The conditions below apply to the curves on pages 16 to 72:

General conditions

- Curve tolerances according to ISO 9906, Annex A.
- The performance curves show pump performance at actual speed, cf. standard motor range. The speeds of the motors are approximately
4" motors: $n = 2870 \text{ min}^{-1}$
6" motors: $n = 2870 \text{ min}^{-1}$
8" to 12" motors: $n = 2900 \text{ min}^{-1}$.
- The measurements were made with airless water at a temperature of 20 °C. The curves apply to a kinematic viscosity of 1 mm²/s (1 cSt). When pumping liquids with a density higher than that of water, use motors with correspondingly higher outputs.
- The **bold** curves indicate the **recommended** performance range.
- The performance curves are inclusive of possible losses such as non-return valve loss.

SP A curves

- **Q/H:** The curves are inclusive of valve and inlet losses at the actual speed.
- **Power curve:** P₂ shows pump power input at the actual speed for each individual pump size.
- **Efficiency curve:** Eta shows pump stage efficiency.

SP curves

- **Q/H:** The curves are inclusive of valve and inlet losses at the actual speed. Operation without non-return valve will increase the actual head at rated performance by 0.5 to 1.0 m.
- **NPSH:** The curve is inclusive of pressure loss in the suction interconnector and shows required inlet pressure.
- **Power curve:** P₂ shows pump power input at the actual speed of each individual pump size.
- **Efficiency curve:** Eta shows pump stage efficiency. If Eta for the actual pump size is needed, please consult WinCAPS or WebCAPS.

Pump range

Type	SP 1A	SP 2A	SP 3A	SP 5A	SP 8A	SP 14A	SP 17	SP 30	SP 46	SP 60	SP 77	SP 95	SP 125	SP 160	SP 215
Steel: EN 1.4301 AISI 304	•	•	•	•	•	•	•	•	•	•	•	•	•	•	•
Steel: EN 1.4401 AISI 316			•	•	•	•	•	•	•	•	•	•	•	•	•
Steel: EN 1.4539 AISI 904L				•	•		•	•	•	•	•	•	•	•	•
Connection*	Rp 1 1/4	Rp 1 1/4 (R 1 1/4)	Rp 1 1/4	Rp 1 1/2 (R 1 1/2)	Rp 2 (R 2)	Rp 2	Rp 2 1/2 (R 3)	Rp 3 (R 3)	Rp 3 Rp 4 (R 4)	Rp 3 Rp 4	Rp 5	Rp 5	Rp 6	Rp 6	Rp 6
Flange connection: Grundfos flange											5"	5"	6"	6"	6"

* Figures in brackets () indicate connection for pumps with sleeve.

Motor range

Motor output [kW]	0.37	0.55	0.75	1.1	1.5	2.2	3.0	3.7	4.0	5.5	7.5	9.2	11	13	15	18.5	22	26	30	37	45	55	63	75	92	110	132	147	170	190	220	250		
Single-phase	•	•	•	•	•	•																												
Three-phase	•	•	•	•	•	•	•	•	•	•	•	•	•	•	•	•	•	•	•	•	•	•	•	•	•	•	•	•	•	•	•	•	•	
Industrial motor and MS6 T60 versions						•	•	•	•	•	•	•	•	•	•	•	•	•	•	•	•	•	•	•	•	•	•	•	•	•	•	•	•	
Rewindable motor								•	•	•	•	•	•	•	•	•	•	•	•	•	•	•	•	•	•	•	•	•	•	•	•	•	•	
Steel: EN 1.4301 AISI 304	•	•	•	•	•	•	•	•	•	•	•	•	•	•	•	•	•	•	•	•	•	•	•	•	•	•	•	•	•	•	•	•	•	
Steel: EN 1.4301 and cast iron									•	•	•	•	•	•	•	•	•	•	•	•	•	•	•	•	•	•	•	•	•	•	•	•	•	•
Steel: EN 1.4401 AISI 316									•	•	•	•	•	•	•	•	•	•	•	•	•	•	•	•	•	•	•	•	•	•	•	•	•	•
Steel: EN 1.4539 AISI 904L			•	•	•	•	•	•	•	•	•	•	•	•	•	•	•	•	•	•	•	•	•	•	•	•	•	•	•	•	•	•	•	•
Built-in temperature transmitter in motor			•	•	•	•	•	•	•	•	•	•	•	•	•	•	•	•	•	•	•	•	•	•	•	•	•	•	•	•	•	•	•	•

Direct-on-line starting is recommended up to 75 kW.

Soft starter or autotransformer is recommended above 75 kW.

Motors with star-delta starting are available from 5.5 kW.

Motor protection and controllers

Motor output [kW]	0.37	0.55	0.75	1.1	1.5	2.2	3.0	3.7	4.0	5.5	7.5	9.2	11	13	15	18.5	22	26	30	37	45	55	63	75	92	110	132	147	170	190	220	250			
CUE		•	•	•	•	•	•	•	•	•	•	•	•	•	•	•	•	•	•	•	•	•	•	•	•	•	•	•	•	•	•	•	•		
MP 204	•	•	•	•	•	•	•	•	•	•	•	•	•	•	•	•	•	•	•	•	•	•	•	•	•	•	•	•	•	•	•	•	•		
IO 112	•	•	•	•	•	•	•	•	•	•	•	•	•	•	•	•	•	•	•	•	•	•	•	•	•	•	•	•	•	•	•	•	•	•	
Pr 5714								•	•	•	•	•	•	•	•	•	•	•	•	•	•	•	•	•	•	•	•	•	•	•	•	•	•	•	
CU 220								•	•	•	•	•	•	•	•	•	•	•	•	•	•	•	•	•	•	•	•	•	•	•	•	•	•	•	
Pt100								•	•	•	•	•	•	•	•	•	•	•	•	•	•	•	•	•	•	•	•	•	•	•	•	•	•	•	
Pt1000								•	•	•	•	•	•	•	•	•	•	•	•	•	•	•	•	•	•	•	•	•	•	•	•	•	•	•	
Zinc anode				•	•	•	•	•	•	•	•	•	•	•	•	•	•	•	•	•	•	•	•	•	•	•	•	•	•	•	•	•	•	•	
Vertical flow sleeve	•	•	•	•	•	•	•	•	•	•	•	•	•	•	•	•	•	•	•	•	•	•	•	•	•	•	•	•	•	•	•	•	•	•	
Flow sleeve	•	•	•	•	•	•	•	•	•	•	•	•	•	•	•	•	•	•	•	•	•	•	•	•	•	•	•	•	•	•	•	•	•	•	
SA-SPM	•	•	•	•	•	•	•	•	•	•	•	•	•	•	•	•	•	•	•	•	•	•	•	•	•	•	•	•	•	•	•	•	•	•	
R100	•	•	•	•	•	•	•	•	•	•	•	•	•	•	•	•	•	•	•	•	•	•	•	•	•	•	•	•	•	•	•	•	•	•	•
G100	•	•	•	•	•	•	•	•	•	•	•	•	•	•	•	•	•	•	•	•	•	•	•	•	•	•	•	•	•	•	•	•	•	•	•

Motor protection of single-phase motors, see *Electrical data*, page 73.

Features and benefits

A wide pump range

Grundfos offers energy-efficient submersible pumps ranging from 1 to 280 m³/h. The pump range consists of many pump sizes, and each pump size is available with an optional number of stages to match any duty point.

High pump efficiency

Often pump efficiency is a neglected factor compared to the price. However, the observant user will notice that price variations are without importance to water supply economics compared to the importance of pump and motor efficiencies.

Example

When pumping 200 m³/h at a head of 100 m for a period of 10 years, EURO 60,000 will be saved if a pump/motor having a 10 % higher efficiency is chosen and the price is EURO 0.10 per kWh.

Material and pumped liquids

Grundfos offers a complete range of pumps and motors which, as standard, are made completely of stainless steel to EN 1.4301 (AISI 304). This ensures good wear resistance and a reduced risk of corrosion when pumping ordinary cold water with a minor chloride content.

A pump range made of upgraded stainless steel is available for more aggressive liquids:

SP N: EN 1.4401 (AISI 316)

SP R: EN 1.4539 (AISI 904L).

Alternatively, a complete range of zinc anodes for cathodic protection is available. See page 90. For example this may be advisable for seawater applications.

For slightly polluted liquids containing for example oil, Grundfos offers a complete range of stainless-steel SP NE pumps to EN 1.4401 (AISI 316) with all rubber parts made of FKM.

Low installation costs

Stainless steel means low weight facilitating the handling of pumps and resulting in low equipment costs and reduced installation and service time.

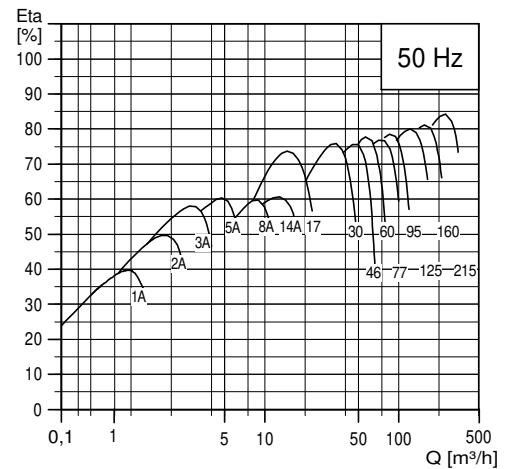

TM00 7255 1898

Fig. 1 Pump/motor efficiencies in relation to flow



Gr6389 - GrA4019

Fig. 2 Various SP pumps

Bearings with sand channels

All bearings are water-lubricated and have a squared shape enabling sand particles, if any, to leave the pump together with the pumped liquid.

Inlet strainer

The inlet strainer prevents particles over a certain size from entering the pump.

Non-return valve

All pumps have a reliable non-return valve in the valve casing preventing back flow in connection with pump stoppage.

Furthermore, the short closing time of the non-return valve means that the risk of destructive water hammer is reduced to a minimum.

The valve casing is designed for optimum hydraulic properties to minimise the pressure loss across the valve and thus to contribute to the high efficiency of the pump.

Priming screw

All Grundfos 4" pumps are fitted with a priming screw. Consequently, dry running is prevented because the priming screw will ensure that the pump bearings are always lubricated.

Due to the semi-axial impellers of large SP pumps, this priming is provided automatically.

However, it applies to all pump types as, if the water table is lowered to a level below the pump inlet, neither pump nor motor will be protected against dry running.

Stop ring

The stop ring prevents damage to the pump during transport and in case of up-thrust in connection with start-up.

The stop ring, which is designed as a thrust bearing, limits axial movements of the pump shaft.

The stationary part of the stop ring (A) is secured in the upper chamber.

The rotating part (B) is fitted above the split cone (C).



Fig. 3 Bearing

TM00 7301 1096



Fig. 4 Inlet strainer

TM00 7302 1096

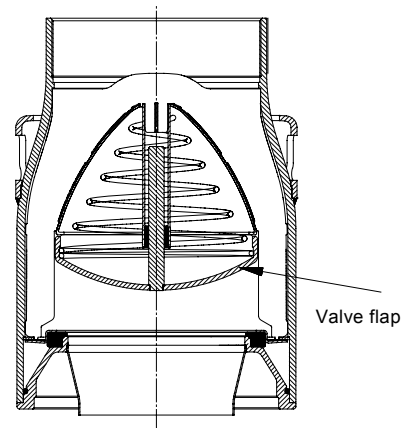

Fig. 5 Non-return valve

TM01 2499 1798

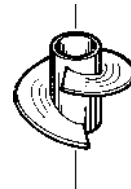

Fig. 6 Priming screw

TM00 7304 1096

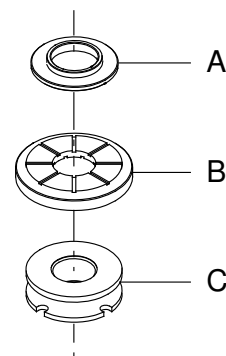
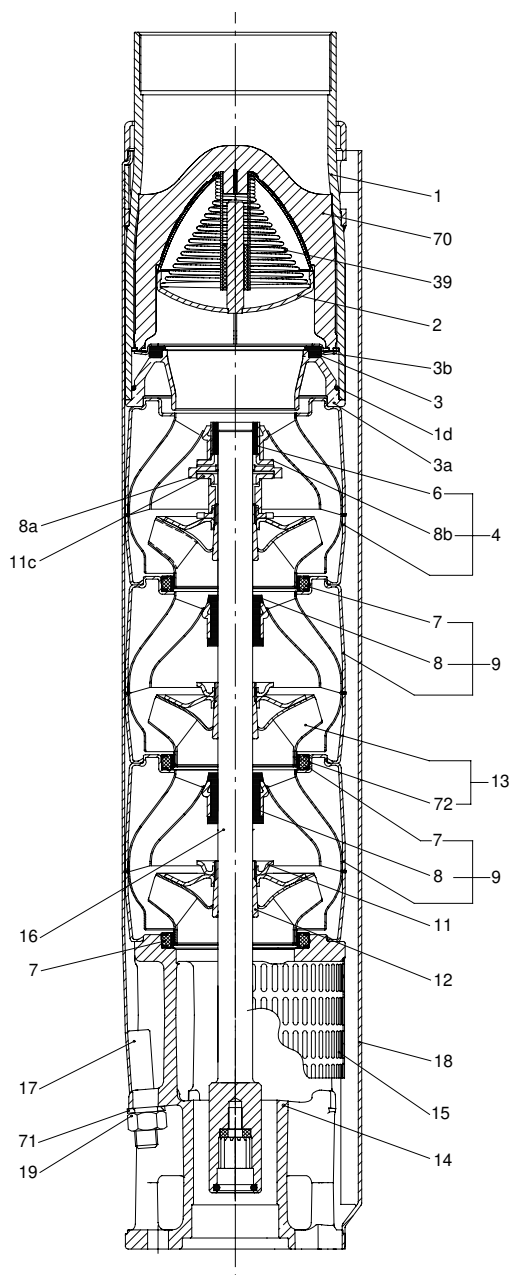

Fig. 7 Stop ring (rotating and stationary parts) and split cone

TM01 3327 3698

Material specification

Pos.	Component	Material	Standard	N-version	R-version
			EN/AISI		
1	Valve casing	Stainless steel	1.4301/ 304	1.4401/ 316	1.4539/ 904L
1d	O-ring	NBR			
2	Valve cup	Stainless steel	1.4301/ 304	1.4401/ 316	1.4539/ 904L
3	Valve seat	Standard/ N-version: NBR R-version: FKM			
3a	Lower valve seat retainer	Stainless steel	1.4308	1.4408/ 316	1.4517
3b	Upper valve seat retainer	Stainless steel	1.4301/ 304	1.4401/ 316	1.4539/ 904L
4	Top chamber	Stainless steel	1.4301/ 304	1.4401/ 316	1.4539/ 904L
6	Upper bearing	Stainless steel/ NBR	1.4401/ 304	1.4401/ 316	1.4539/ 904L
7	Neck ring	NBR/PPS			
8	Bearing	NBR			
8a	Washer for stop ring	Carbon/graphite HY22 in PTFE mass			
8b	Stop ring	Stainless steel	1.4401/ 316	1.4401/ 316	1.4539/ 904L
9	Chamber	Stainless steel	1.4301/ 304	1.4401/ 316	1.4539/ 904L
11	Split cone nut	Stainless steel	1.4301/ 304	1.4401/ 316	1.4539/ 904L
11c	Nut for stop ring	Stainless steel	1.4401/ 316	1.4401/ 316	1.4539/ 904L
12	Split cone	Stainless steel	1.4301/ 304	1.4401/ 316	1.4539/ 904L
13	Impeller	Stainless steel	1.4301/ 304	1.4401/ 316	1.4539/ 904L
14	Suction interconnector	Cast stainless steel	1.4308	1.4408/ 316	1.4517
15	Strainer	Stainless steel	1.4301/ 304	1.4401/ 316	1.4539/ 904L
16	Shaft complete	Stainless steel	1.4057/ 431	1.4460/ 329	1.4460/329
17	Strap	Stainless steel	1.4301/ 304	1.4401/ 316	1.4539/ 904L
18	Cable guard	Stainless steel	1.4301/ 304	1.4401/ 316	1.4539/ 904L
19	Nut for strap	Stainless steel	1.4301/ 304	1.4401/ 316	1.4539/ 904L
39	Spring for valve cup	Stainless steel	1.4301/ 304	1.4401/ 316	1.4462/ SAF 2205
70	Valve guide	Stainless steel	1.4301/ 304	1.4401/ 316	1.4539/ 904L
71	Washer	Stainless steel	1.4401/ 316	1.4401/ 316	1.4539/ 904L
72	Wear ring	Stainless steel	1.4301/ 304	1.4401/ 316	1.4539/ 904L



TM01 2359 2301

Fig. 8 SP 77

Features and benefits

A complete motor range

Grundfos offers a complete range of submersible motors in different voltages:

Submersible motors, MS:

- 4" motors, single-phase up to 2.2 kW:
 - 2-wire
 - 3-wire
 - PSC (permanent split capacitor)
- 4" motors, three-phase up to 7.5 kW
- 6" motors, three-phase from 5.5 kW to 30 kW.

Submersible rewindable motors, MMS:

- 6" motors, three-phase from 3.7 kW up to 37 kW
- 8" motors, three-phase from 22 kW up to 110 kW
- 10" motors, three-phase from 75 kW up to 190 kW
- 12" motors, three-phase from 147 kW up to 250 kW.

High motor efficiency

Within the area of high motor efficiency, Grundfos is a market leader.

Rewindable motors

The 2-pole Grundfos MMS submersible motors are all easy to rewind. The windings of the stator are made of a special water-proof wire of pure electrolytic copper sheathed with special non-hydroscopic thermoplastic material. The fine dielectric properties of this material allow direct contact between the windings and the liquid for efficient cooling of the windings.

Industrial motors and MS6 T60-versions

For heavy-duty applications, Grundfos offers a complete motor range of industrial motors with up to 5 % higher efficiency than that of Grundfos' standard motors. The industrial motors are available in sizes as from 2.2 kW up to 22 kW. The cooling of the motor is very efficient due to the large motor surface. The efficient cooling makes it possible to increase the liquid temperature to 60 °C at a minimum flow of 0.15 m/s past the motor. The industrial motors are for customers who value low operating costs and long life higher than price.

Grundfos industrial motors are developed for difficult operating conditions. These motors will stand a higher thermal load than standard motors and thus have a longer life when subjected to high load. This applies whether the high load is caused by bad power supply, hot water, bad cooling conditions, high pump load, etc.

Please note that heavy-duty motors are longer than motors for standard conditions.



Fig. 9 MS motors

TM00 7305 1096 - GrA4013



Fig. 10 MMS motors

TM01 7873 4799 - GrA4575

Overtemperature protection

Accessories for protection against overtemperature are available for both Grundfos MS and MMS submersible motors. When the temperature becomes too high, the protection device will cut out, and damage to the pump and motor will be avoided.

Restarting of the motor after cut-out can be achieved in two ways:

- manual restarting or
- automatic restarting.

Automatic restarting means that the MP 204 motor protector attempts to restart the motor after 15 minutes. If the first attempt is not successful, restarting will be reattempted at 30-minute intervals.

MS

Grundfos submersible motors, type MS, except for MS 402, are available with built-in Tempcon (temperature transmitter) for monitoring of the temperature of the submersible motor.

The Grundfos MP 204 motor protector can warn and cut out the motor to provide protection against high temperatures. The signal from the Tempcon to the MP 204 is transmitted via powerline communication.

The MP 204 cannot be used in installations with frequency converters. Grundfos recommends to monitor the motor temperature via a Pt100 or Pt1000 sensor.

The Grundfos frequency converter, type CUE, can handle Pt100 or Pt1000 signals via an add-on card without any additional relays.

Grundfos offers the CU 220 (only Pt1000 and 50 Hz) or the PR 5714 as relays. These solutions require extra cabling for the temperature sensor.

MMS

Grundfos submersible motors, type MMS, can be fitted with a Pt100 or Pt1000 sensor for monitoring of the motor temperature. Grundfos offers the CU 220 or PR 5714 as relays.

The Grundfos frequency converter, type CUE, can handle Pt100 or Pt1000 signals via a small add-on card without any additional relays.

Protection against upthrust

In case of a very low counter-pressure in connection with start-up, there is a risk that the entire chamber stack may rise. This is called upthrust. Upthrust may damage both pump and motor. Therefore, both Grundfos pumps and motors are protected against upthrust as standard, preventing upthrust from occurring in the critical start-up phase. The protection consists of either a built-in stop ring or hydraulic balancing.

Built-in cooling chambers

In all Grundfos MS submersible motors, an efficient cooling is ensured by cooling chambers at the top and at the bottom of the motor and by an internal circulation of motor liquid. See fig. 11. As long as the required flow velocity past the motor is maintained (see *General data* on page 4), cooling of the motor will be efficient.

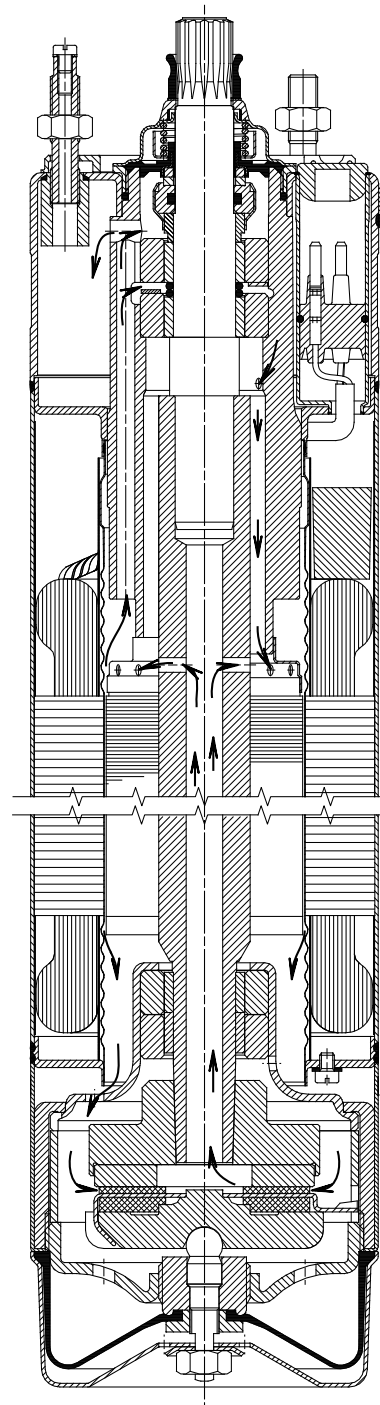

Fig. 11 MS 4000

TM00 5698 0996

Lightning protection

The smallest Grundfos submersible motors, i.e. MS 402, are all insulated in order to minimise the risk of motor burnout caused by stroke of lightning.

Reduced risk of short-circuit

The embedded stator winding in the Grundfos MS submersible motor is hermetically enclosed in stainless steel. The result is high mechanical stability and optimum cooling. Also, this eliminates the risk of short-circuit of the windings caused by condensed water.

Shaft seal

MS 402

The shaft seal is of the lip seal type characterised by low friction against the rotor shaft.

The choice of rubber offers good wear resistance, good elasticity and resistance to particles. The rubber material is approved for use in drinking water.

MS 4000, MS6

The material is ceramic/tungsten carbide providing optimum sealing, optimum wear resistance and long life.

The spring-loaded shaft seal is designed with a large surface and a sand shield. The result is a minimum exchange of pumped liquid and motor liquid and no penetration of particles. Motors, version R, have a SiC/SiC shaft seal according to DIN 24960. Other combinations are available on request.

MMS rewindable motors

The standard shaft seal is a ceramic/carbon mechanical shaft seal. The shaft seal is replaceable.

The material provides good wear resistance and resistance to particles.

Together with the shaft seal housing, the sand shield forms a labyrinth seal, which during normal operating conditions prevents penetration of sand particles into the shaft seal.

On request, motors can be supplied with a SiC/SiC seal according to DIN 24960.

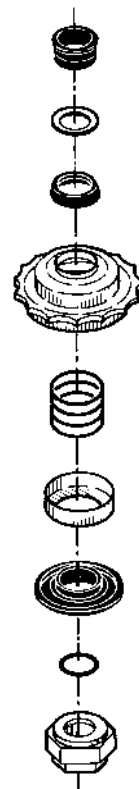

Fig. 12 Shaft seal, MS 4000

TM00 7306 2100



Fig. 13 Shaft seal, MS6

TM03 9225 3607

Material specification for MS motors

MS 402 and MS 4000 submersible motors

Pos.	Component	MS 402	MS 4000
1	Shaft	EN 1.4057	EN 1.4057
2	Shaft seal	NBR	Tungsten carbide/ ceramic
3	Motor sleeve	EN 1.4301	EN 1.4301
4	Motor end shield		EN 1.4301
5	Radial bearing	Ceramic	Ceramic/ tungsten carbide
6	Axial bearing	Ceramic/carbon	Ceramic/carbon
	Rubber parts	NBR	NBR

R-version motor

Pos.	Component	MS 4000
1	Shaft	EN 1.4462
2	Shaft seal	NBR/ceramic
3	Motor sleeve	EN 1.4539
4	Motor end shield	EN 1.4539
5	Radial bearing	Ceramic/ tungsten carbide
6	Thrust bearing	Ceramic/carbon
	Rubber parts	NBR

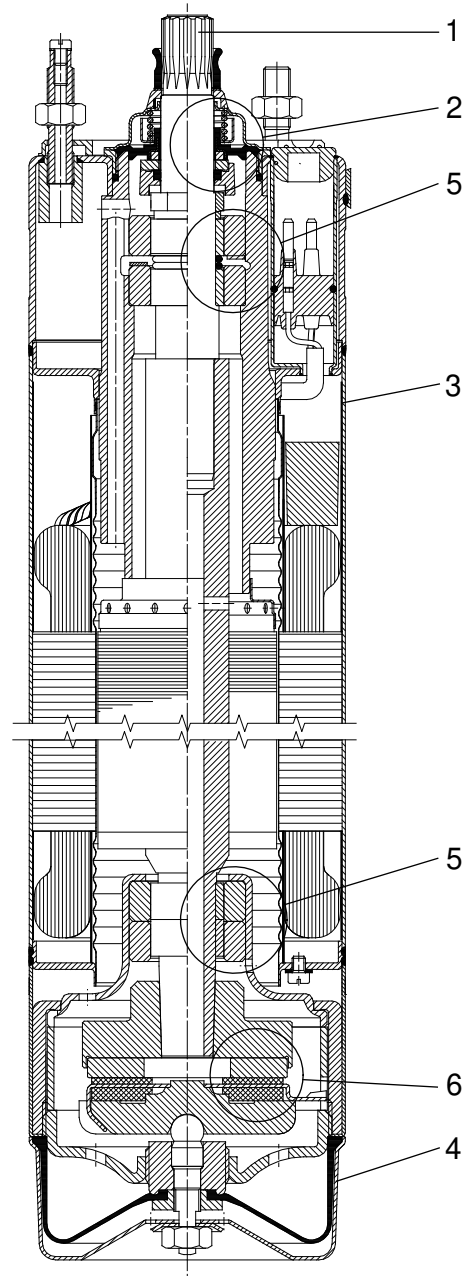

TM00 7865 2196

Fig. 14 MS 4000

MS6 submersible motors

Pos.	Component	MS6
202	Shaft with rotor	EN 1.4462
2	Shaft seal	Ceramic/carbon
3	Motor sleeve	EN 1.4301
4	Motor end cover	EN 1.4308
	Rubber parts	NBR/FKM

R-version motor

Pos.	Component	MS6
1	Shaft	EN 1.4462
2	Shaft seal	SiC/SiC
3	Motor sleeve	EN 1.4539
4	Motor end cover	EN 1.4517
	Rubber parts	FKM

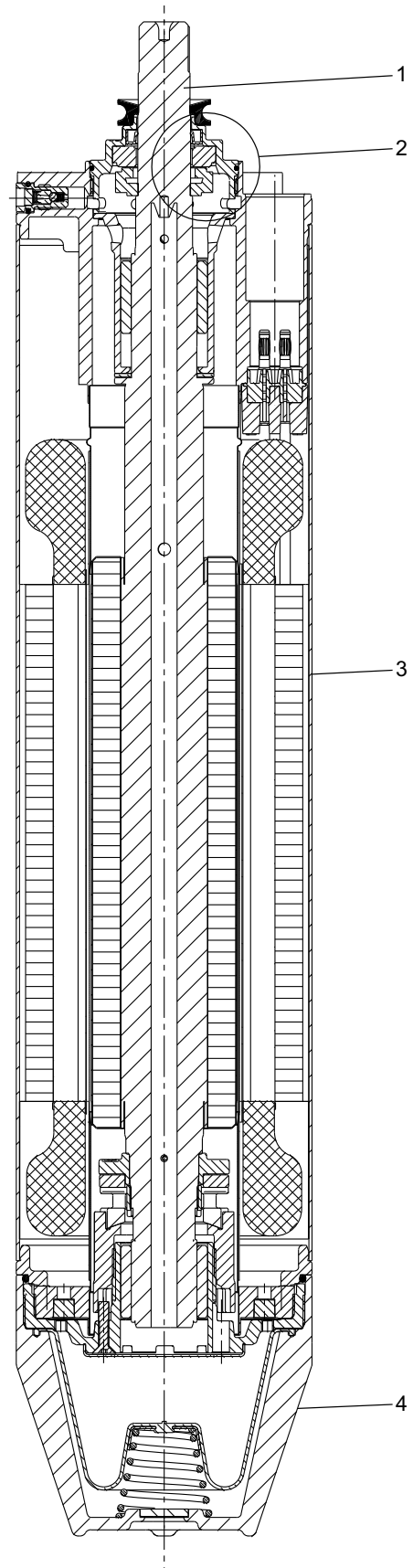

Fig. 15 MS6

TM03 9226 3607

Material specification for MMS 6000 to 12000 motors

Submersible rewindable motors

Pos.	Component	Material	EN
202	Shaft	Steel	1.0533
202a	Shaft ends	Stainless steel	1.4460
203/ 206	Thrust bearing Stationary/ rotating part	6" 3.7 to 15 kW	Hardened steel/EPDM
		12"	
		6" 18.5 to 37 kW	Ceramic/ carbon
		8" to 10"	
204	Bearing bush	Carbon	
		12"	Stainless steel/ NBR
205	Bearing housing, upper	Cast iron	EN-JL1040
212	Diaphragm	CR	
213	Motor end shield	Cast iron	EN-JL1040
218	Motor sleeve	Stainless steel	1.4301
220	Motor cable	EPDM	
226	Shaft seal	Ceramic/ carbon	
235	Intermediate housing	Cast iron	EN-JL1040
236	Bearing housing, lower	Cast iron	EN-JL1040

N- and R-versions of MMS motors

Pos.	Component	Material	Version	
			N	R*
			EN	EN
202	Shaft	Steel	1.0533	1.0533
202a	Shaft ends	Stainless steel	1.4460	1.4462
203/ 206	Thrust bearing Stationary/rotating part: • 6" (3.7 to 15 kW) • 12"	Hardened steel/EPDM		
		Ceramic/ carbon		
204	Bearing bush • 6" to 10"	Carbon		
	Bearing bush • 12"	Stainless steel/ NBR		
205	Bearing housing, upper	Stainless steel	1.4401	1.4539
212	Diaphragm	CR		
213	Motor end shield	Stainless steel	1.4401	1.4539
218	Motor sleeve	Stainless steel	1.4401	1.4539
220	Motor cable	EPDM		
226	Shaft seal	Ceramic/ carbon		
235	Intermediate housing	Stainless steel	1.4401	1.4539
236	Bearing housing, lower	Stainless steel	1.4401	1.4539

* MMS 6000, MMS 8000 and MMS10000 are available in R-versions.

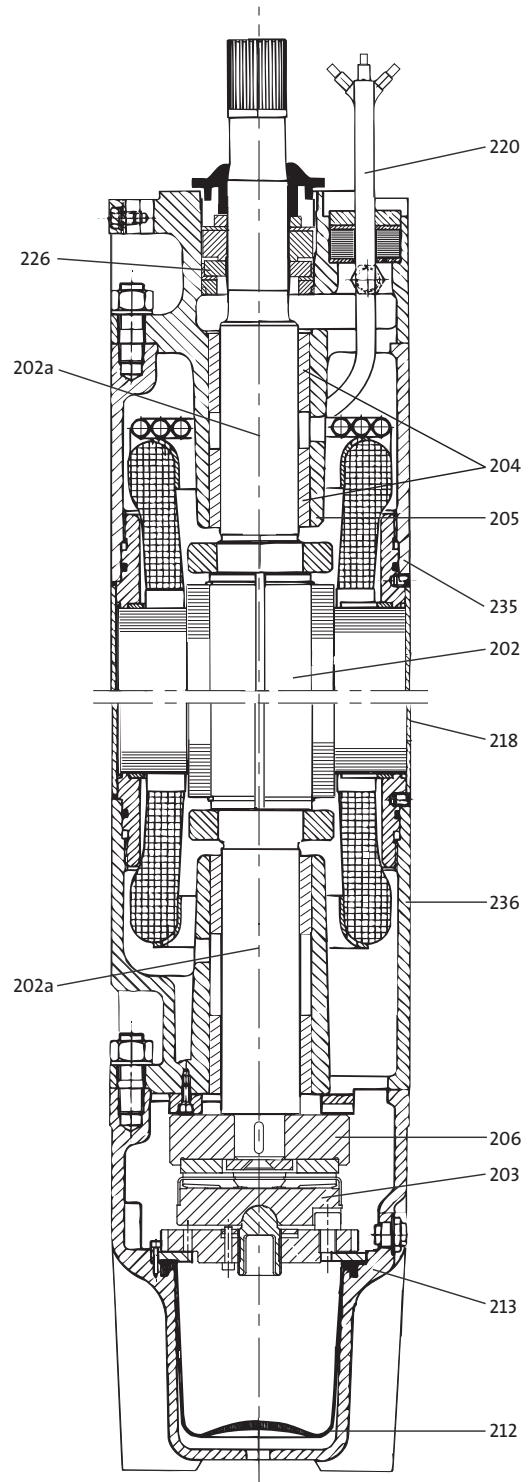
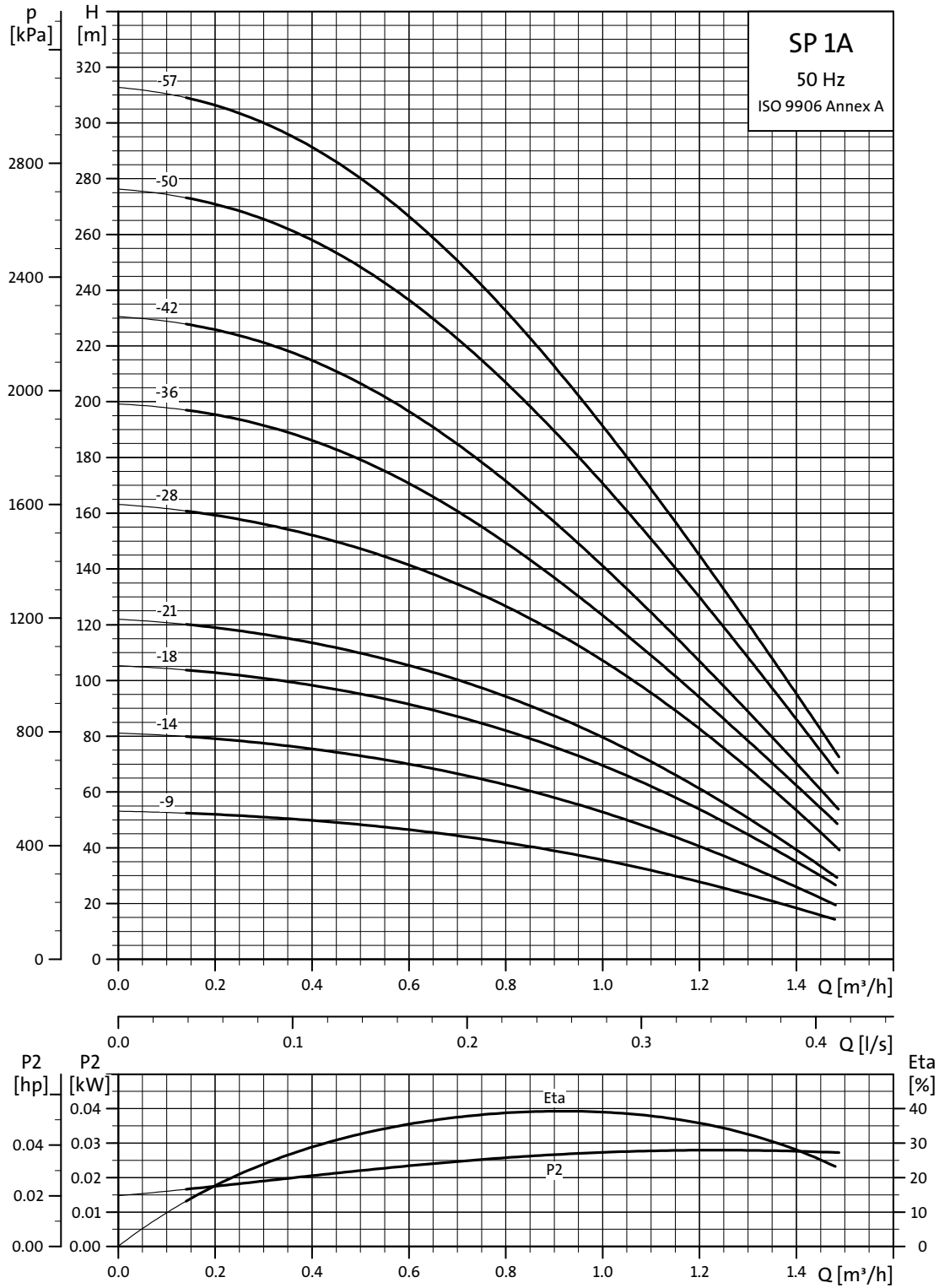

Fig. 16 MMS 10000

TM01 4985 0404

SP 1A



Explanation of efficiency curve, please see *Curve conditions*, page 4.

TM00 7271 4702

Dimensions and weights

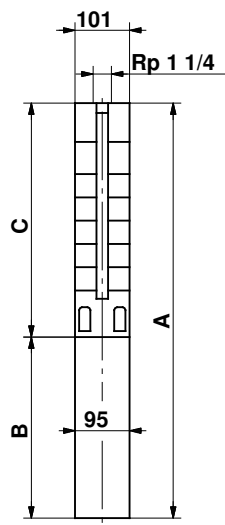

TM00 0955 1196

101 mm = Maximum diameter of pump inclusive of cable guard and motor.

Pump type	Motor		C	Dimensions [mm]				Net weight [kg]	
	Type	Power [kW]		B		A		1x230V	3x230V 3x400V
				1x230V	3x230V 3x400V	1x230V	3x230V 3x400V		
SP 1A-9	MS 402	0.37	344	256	226	600	570	11	9
SP 1A-14	MS 402	0.37	449	256	226	705	675	12	10
SP 1A-18	MS 402	0.55	533	291	241	824	774	14	12
SP 1A-21	MS 402	0.55	596	291	241	887	837	14	12
SP 1A-28	MS 402	0.75	743	306	276	1049	1019	16	15
SP 1A-36	MS 402	1.1	956	346	306	1302	1262	25	23
SP 1A-42	MS 402	1.1	1082	346	306	1428	1388	27	25
SP 1A-50	MS 402	1.5	1250	346	346	1596	1596	30	29
SP 1A-57	MS 402	1.5	1397	346	346	1743	1743	32	32

SP 2A

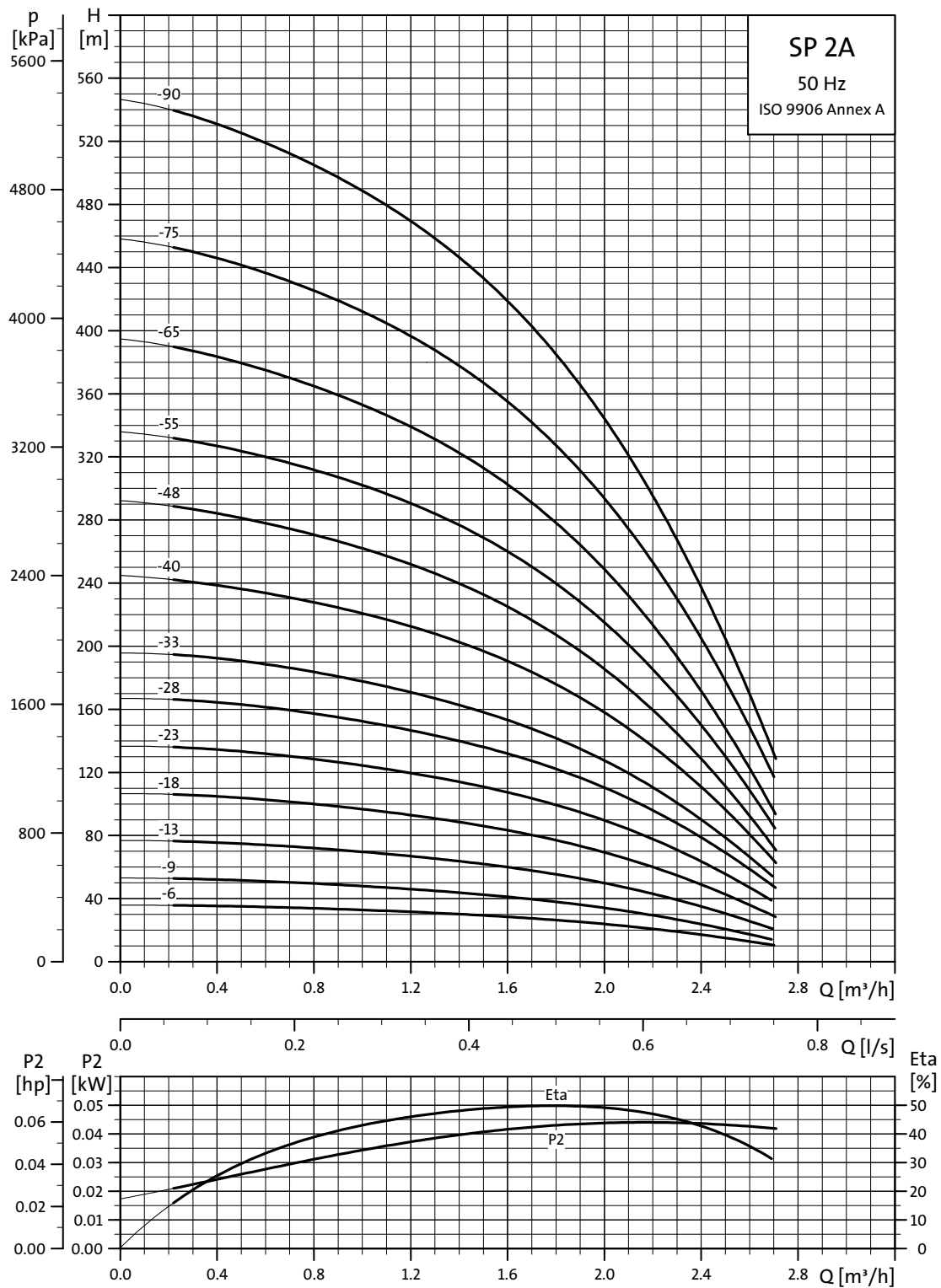

TM00 7272 4702

Explanation of efficiency curve, please see *Curve conditions*, page 4.

Dimensions and weights

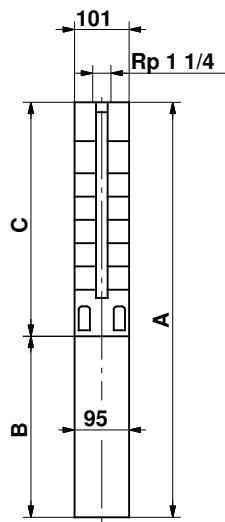

TM00 0955 1196

Pump type	Motor			Dimensions [mm]				Net weight [kg]	
	Type	Power [kW]	C	B		A		1x230V	3x230V 3x400V
				1x230V	3x230V 3x400V	1x230V	3x230V 3x400V		
SP 2A-6	MS 402	0.37	281	256	226	537	507	10	9
SP 2A-9	MS 402	0.37	344	256	226	600	570	11	9
SP 2A-13	MS 402	0.55	428	291	241	719	669	13	11
SP 2A-18	MS 402	0.75	533	306	276	839	809	15	13
SP 2A-23	MS 402	1.1	638	346	306	984	944	17	16
SP 2A-28	MS 402	1.5	743	346	346	1089	1089	19	18
SP 2A-33	MS 402	1.5	844	346	346	1190	1190	20	19
SP 2A-40	MS 4000	2.2	1040	573		1613		37	
SP 2A-40	MS 402	2.2	1040		346		1386		27
SP 2A-48	MS 4000	2.2	1208	573		1781		39	
SP 2A-48	MS 402	2.2	1208		346		1554		30
SP 2A-55	MS 4000	3.0	1355		493		1848		38
SP 2A-65	MS 4000	3.0	1565		493		2058		41
SP 2A-75	MS 4000	4.0	1954		573		2527		57
SP 2A-90	MS 4000	4.0	2269		573		2842		64

101 mm = Maximum diameter of pump inclusive of cable guard and motor.

SP 2A-75 and SP 2A-90 are mounted in sleeve for R 1 1/4 connection and with max. diameter 108 mm.

SP 3A

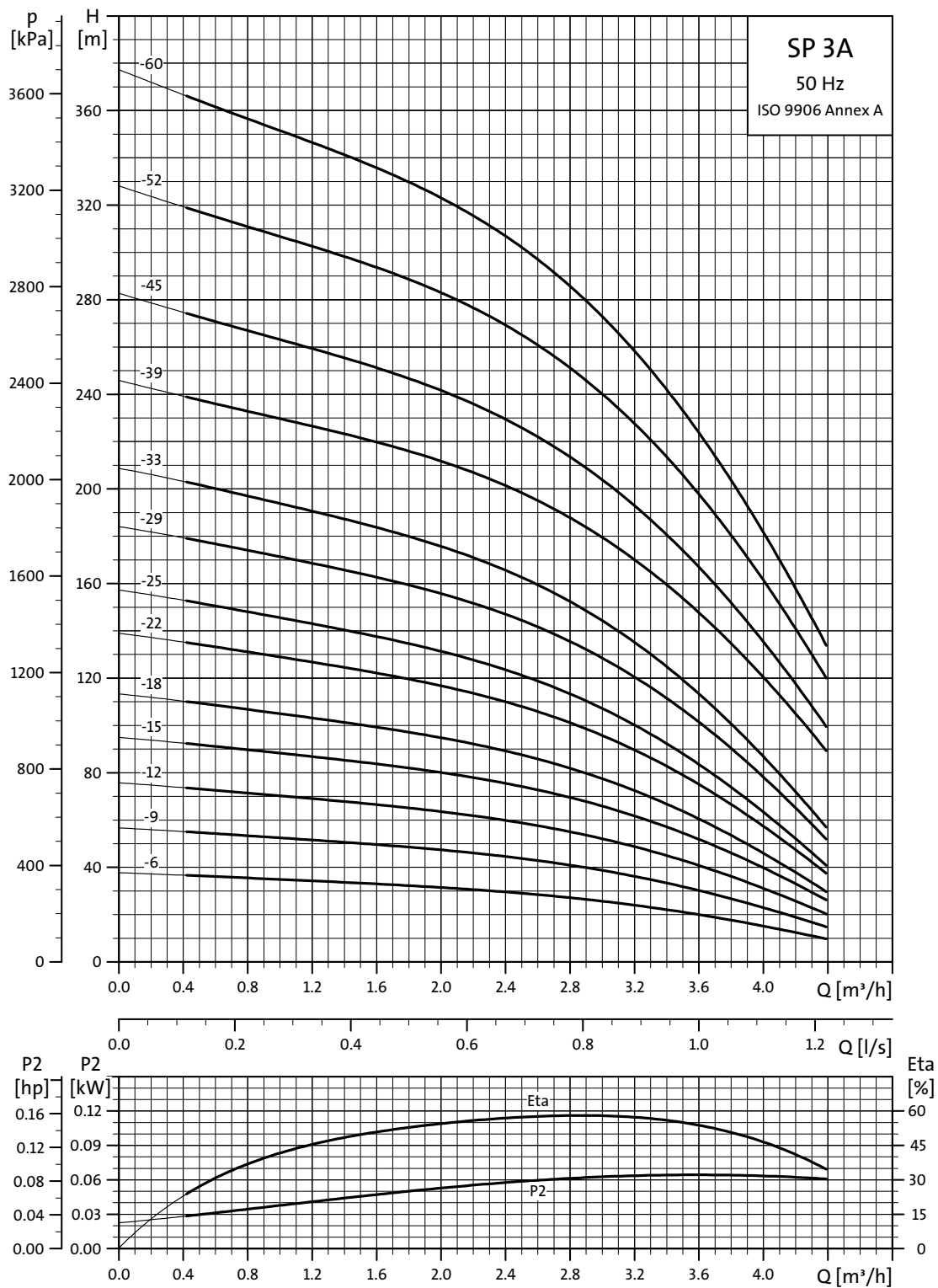

TM00 7273 4702

Explanation of efficiency curve, please see *Curve conditions*, page 4.

Dimensions and weights

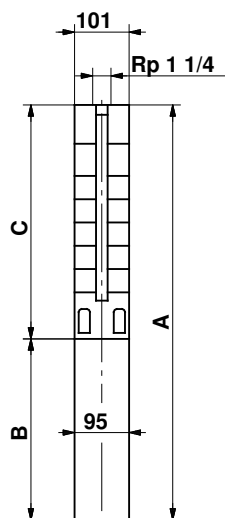

101 mm = Maximum diameter of pump inclusive of cable guard and motor.

TM00 0955 11

Pump type	Motor		C	Dimensions [mm]				Net weight [kg]	
	Type	Power [kW]		B		A		1x230V	3x230V 3x400V
				1x230V	3x230V 3x400V	1x230V	3x230V 3x400V		
SP 3A-6	MS 402	0.37	281	256	226	537	507	10	9
SP 3A-6N	MS 4000R	2.2	326	573		899		26	
SP 3A-6N	MS 4000R	0.75	326		398		724		18
SP 3A-9	MS 402	0.55	344	291	241	635	585	12	10
SP 3A-9N	MS 4000R	2.2	389	573		962		27	
SP 3A-9N	MS 4000R	0.75	389		398		787		19
SP 3A-12	MS 402	0.75	407	306	276	713	683	13	12
SP 3A-12N	MS 4000R	2.2	452	573		1025		28	
SP 3A-12N	MS 4000R	0.75	452		398		850		20
SP 3A-15	MS 402	1.1	470	346	306	816	776	16	14
SP 3A-15N	MS 4000R	2.2	515	573		1088		29	
SP 3A-15N	MS 4000R	1.1	515		413		928		22
SP 3A-18	MS 402	1.1	533	346	306	879	839	16	15
SP 3A-18N	MS 4000R	2.2	578	573		1151		30	
SP 3A-18N	MS 4000R	1.1	578		413		991		23
SP 3A-22	MS 402	1.5	617	346	346	963	963	18	17
SP 3A-22N	MS 4000R	2.2	662	573		1235		31	
SP 3A-22N	MS 4000R	1.5	662		413		1075		24
SP 3A-25	MS 402	1.5	680	346	346	1026	1026	18	18
SP 3A-25N	MS 4000R	2.2	725	573		1298		32	
SP 3A-25N	MS 4000R	1.5	725		413		1138		25
SP 3A-29	MS 4000	2.2	764	573		1337		29	
SP 3A-29	MS 402	2.2	764		346		1110		20
SP 3A-29N	MS 4000R	2.2	809	573	453	1382	1262	33	28
SP 3A-33	MS 4000	2.2	848	573		1421		30	
SP 3A-33	MS 402	2.2	848		346		1194		21
SP 3A-33N	MS 4000R	2.2	893	573	453	1466	1346	34	29
SP 3A-39	MS 4000	3.0	1019		493		1512		32
SP 3A-39N	MS 4000R	3.0	1019		493		1512		32
SP 3A-45	MS 4000	3.0	1145		493		1638		34
SP 3A-45N	MS 4000R	3.0	1145		493		1638		34
SP 3A-52	MS 4000	4.0	1292		573		1865		41
SP 3A-52N	MS 4000R	4.0	1292		573		1865		41
SP 3A-60	MS 4000	4.0	1460		573		2033		43
SP 3A-60N	MS 4000R	4.0	1460		573		2033		43

SP 5A

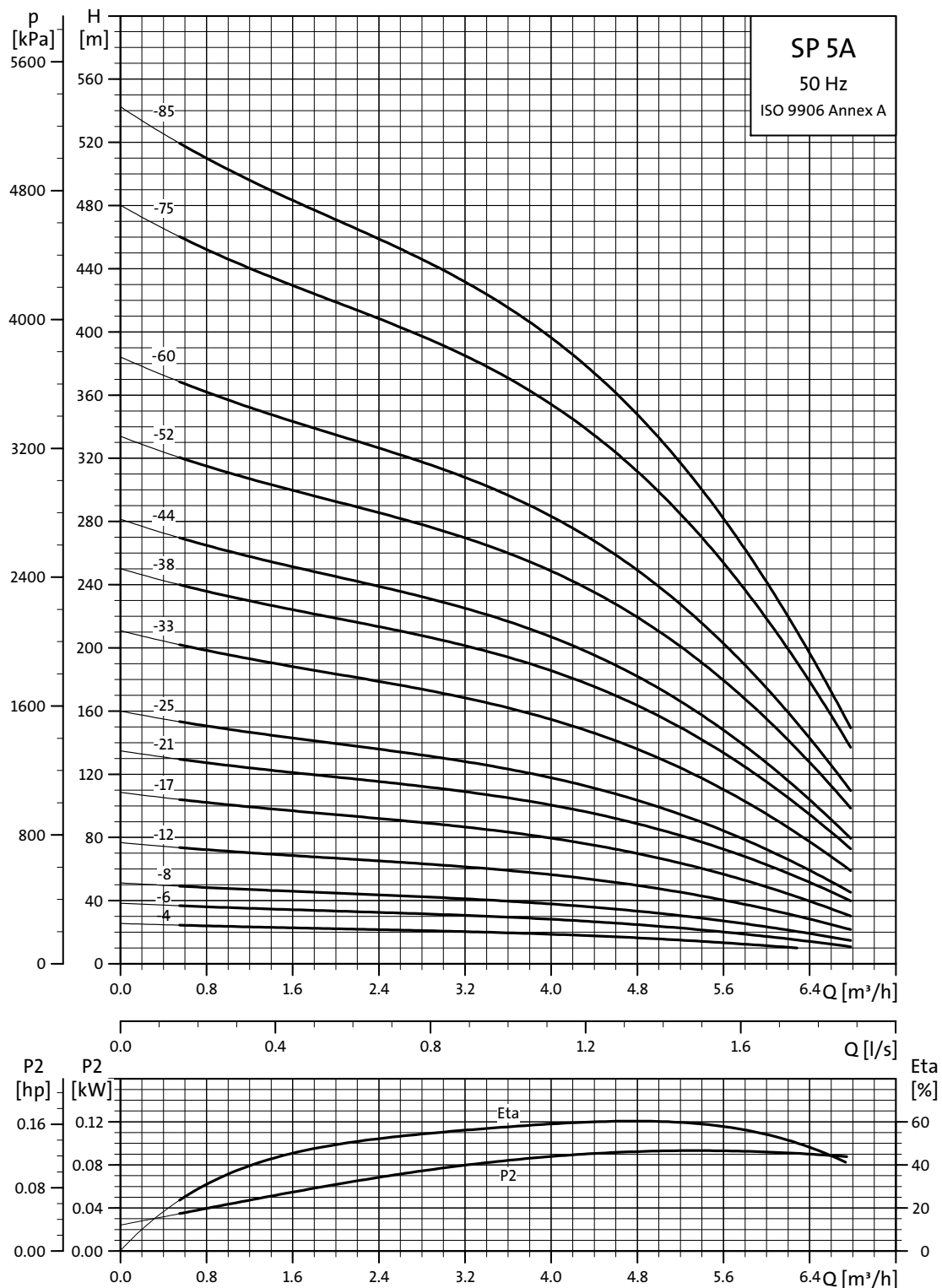

TM00 7274 4702

Explanation of efficiency curve, please see *Curve conditions*, page 4.

Dimensions and weights

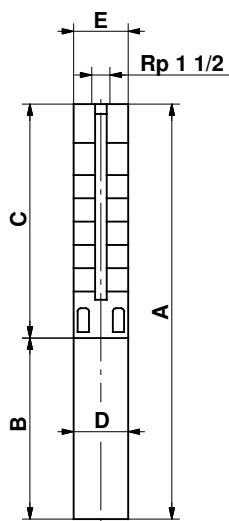

SP 5A-75 and SP 5A-85 are mounted in sleeve for R 1 1/2 connection.

TM00 0956 1196

Pump type	Motor		Dimensions [mm]							Net weight [kg]	
	Type	Power [kW]	C	B		A		D	E	1x230V	3x230V 3x400V
				1x230V	3x230V 3x400V	1x230V	3x230V 3x400V				
SP 5A-4	MS 402	0.37	240	256	226	496	466	95	101	10	8
SP 5A-4N	MS 4000R	2.2	284	573		857		95	101	25	
SP 5A-4N	MS 4000R	0.75	284		398		682	95	101		17
SP 5A-6	MS 402	0.55	282	291	241	573	523	95	101	11	10
SP 5A-6N	MS 4000R	2.2	326	573		899		95	101	26	
SP 5A-6N	MS 4000R	0.75	326		398		724	95	101		18
SP 5A-8	MS 402	0.75	324	306	276	630	600	95	101	13	11
SP 5A-8N	MS 4000R	2.2	368	573		941		95	101	27	
SP 5A-8N	MS 4000R	0.75	368		398		766	95	101		19
SP 5A-12	MS 402	1.1	408	346	306	754	714	95	101	15	13
SP 5A-12N	MS 4000R	2.2	452	573		1025		95	101	28	
SP 5A-12N	MS 4000R	1.1	452		413		865	95	101		21
SP 5A-17	MS 402	1.5	513	346	346	859	859	95	101	17	16
SP 5A-17N	MS 4000R	2.2	557	573		1130		95	101	29	
SP 5A-17N	MS 4000R	1.5	557		413		970	95	101		22
SP 5A-21	MS 4000	2.2	597	573		1170		95	101	27	
SP 5A-21	MS 402	2.2	597		346		943	95	101		18
SP 5A-21N	MS 4000R	2.2	641	573	453	1214	1094	95	101	30	25
SP 5A-25	MS 4000	2.2	681	573		1254		95	101	28	
SP 5A-25	MS 402	2.2	681		346		1027	95	101		19
SP 5A-25N	MS 4000R	2.2	725	573	453	1298	1178	95	101	32	27
SP 5A-33	MS 4000	3.0	849		493		1342	95	101		26
SP 5A-33N	MS 4000R	3.0	893		493		1386	95	101		30
SP 5A-38	MS 4000	4.0	998		573		1571	95	101		36
SP 5A-38N	MS 4000R	4.0	998		573		1571	95	101		36
SP 5A-44	MS 4000	4.0	1124		573		1697	95	101		38
SP 5A-44N	MS 4000R	4.0	1124		573		1697	95	101		38
SP 5A-52	MS 4000	5.5	1292		673		1965	95	101		46
SP 5A-52N	MS 4000R	5.5	1292		673		1965	95	101		46
SP 5A-60	MS 4000	5.5	1460		673		2133	95	101		48
SP 5A-60N	MS 4000R	5.5	1460		673		2133	95	101		48
SP 5A-52	MS6	5.5	1354		535		1889	143	138		60
SP 5A-52N	MS6R	5.5	1354		535		1889	143	138		60
SP 5A-60	MS6	5.5	1522		535		2057	143	138		63
SP 5A-60N	MS6R	5.5	1522		535		2057	143	138		63
SP 5A-75	MS6	7.5	2146		565		2711	143	140		86
SP 5A-85	MS6	7.5	2356		565		2921	143	140		92

E=Maximum diameter of pump inclusive of cable guard and motor.

SP 8A

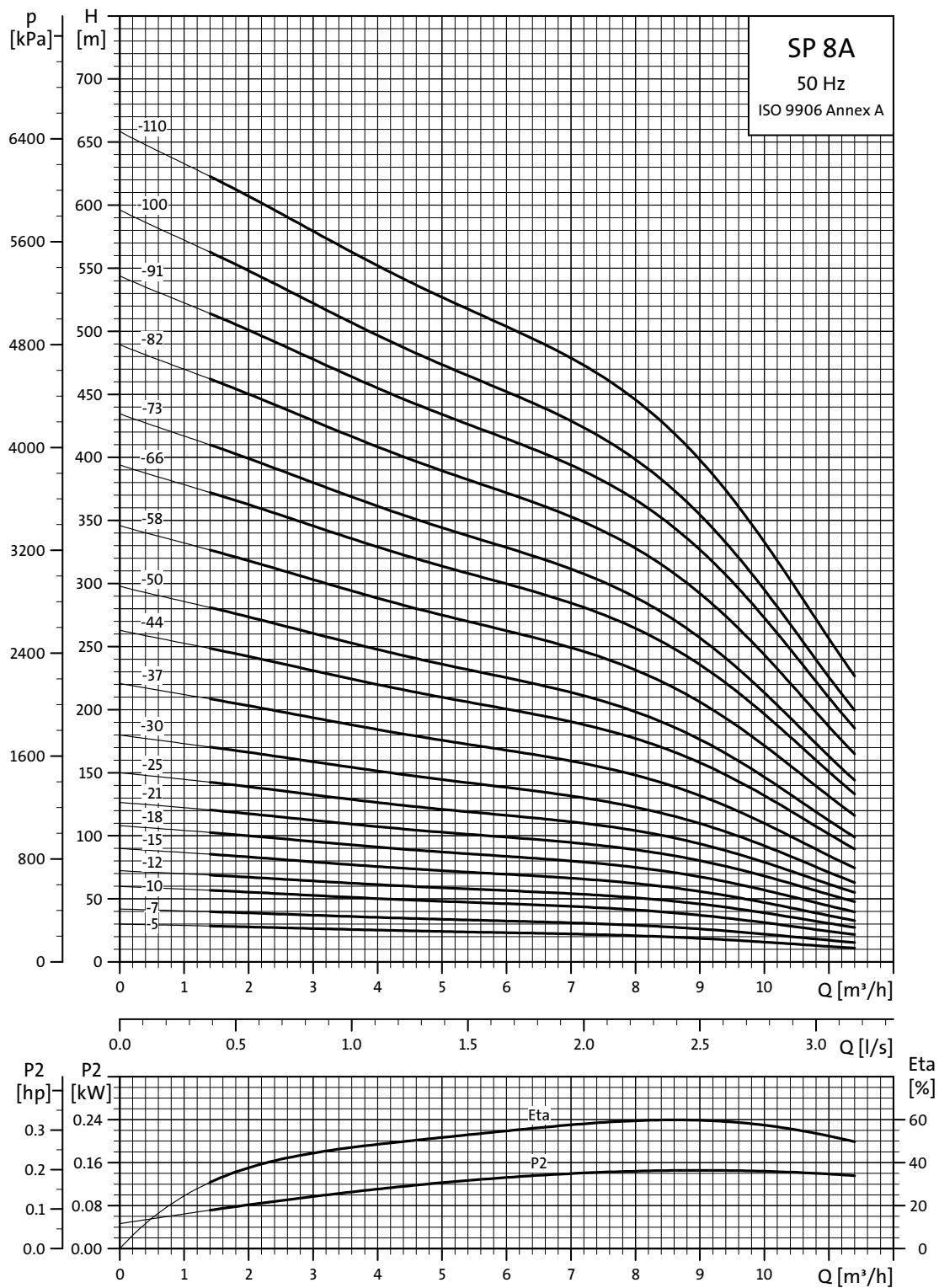

TM00 7275 4702

Explanation of efficiency curve, please see *Curve conditions*, page 4.

Dimensions and weights

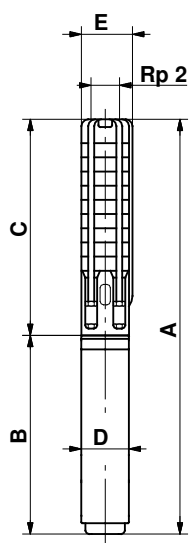

TM00 0957 1196

SP 8A-58(N) to SP 8A-110(N) are mounted in sleeve for R 2 connection.

Pump type	Motor		Dimensions [mm]						Net weight [kg]		
	Type	Power [kW]	C	B		A		D	E	Net weight [kg]	
				1x230V	3x230V 3x400V	1x230V	3x230V 3x400V			1x230V	3x230V 3x400V
SP 8A-5	MS 402	0.75	409	306	276	715	685	95	101	15	13
SP 8A-5N (R)	MS 4000R	2.2	409	573		982		95	101	27	
SP 8A-5N (R)	MS 4000R	0.75	409		398		807	95	101		19
SP 8A-7	MS 402	1.1	493	346	306	839	799	95	101	17	16
SP 8A-7N (R)	MS 4000R	2.2	493	573		1066		95	101	28	
SP 8A-7N (R)	MS 4000R	1.1	493		413		906	95	101		21
SP 8A-10	MS 402	1.5	619	346	346	965	965	95	101	19	19
SP 8A-10N (R)	MS 4000R	2.2	619	573		1192		95	101	30	
SP 8A-10N (R)	MS 4000R	1.5	619		413		1032	95	101		23
SP 8A-12	MS 4000	2.2	703	573		1276		95	101	30	
SP 8A-12	MS 402	2.2	703		346		1049	95	101		21
SP 8A-12N (R)	MS 4000R	2.2	703	573	453	1276	1156	95	101	30	25
SP 8A-15	MS 4000	2.2	829	573		1402		95	101	32	
SP 8A-15	MS 402	2.2	829		346		1175	95	101		23
SP 8A-15N (R)	MS 4000R	2.2	829	573	453	1402	1282	95	101	32	27
SP 8A-18	MS 4000	3.0	955		493		1448	95	101		29
SP 8A-18N (R)	MS 4000R	3.0	955		493		1448	95	101		29
SP 8A-21	MS 4000	4.0	1081		573		1654	95	101		35
SP 8A-21N (R)	MS 4000R	4.0	1081		573		1654	95	101		35
SP 8A-25	MS 4000	4.0	1249		573		1822	95	101		37
SP 8A-25N (R)	MS 4000R	4.0	1249		573		1822	95	101		37
SP 8A-30	MS 4000	5.5	1459		673		2132	95	101		45
SP 8A-30N (R)	MS 4000R	5.5	1459		673		2132	95	101		45
SP 8A-37	MS 4000	5.5	1753		673		2426	95	101		49
SP 8A-37N (R)	MS 4000R	5.5	1753		673		2426	95	101		49
SP 8A-30	MS6	5.5	1521		535		2056	143	138		56
SP 8A-30N	MS6R	5.5	1521		535		2056	143	138		56
SP 8A-37	MS6	5.5	1815		535		2350	143	138		60
SP 8A-37N	MS6R	5.5	1815		535		2350	143	138		60
SP 8A-44	MS 4000	7.5	2051		773		2824	95	101		60
SP 8A-44N	MS 4000	7.5	2051		773		2824	95	101		60
SP 8A-44	MS6	7.5	2109		565		2674	143	138		66
SP 8A-44N	MS6R	7.5	2109		565		2674	143	138		66
SP 8A-50	MS 4000	7.5	2303		773		3076	95	101		64
SP 8A-50N	MS 4000	7.5	2303		773		3076	95	101		64
SP 8A-50	MS6	7.5	2361		565		2926	143	138		70
SP 8A-50N	MS6R	7.5	2361		565		2926	143	138		70
SP 8A-58	MS6	9.2	3013		590		3603	143	140		104
SP 8A-58N	MS6R	9.2	3013		590		3603	143	140		104
SP 8A-66	MS6	11.0	3349		683		4032	143	140		114
SP 8A-66N	MS6R	11.0	3349		683		4032	143	140		114
SP 8A-73	MS6	11.0	3643		683		4326	143	140		120
SP 8A-73N	MS6R	11.0	3643		683		4326	143	140		120
SP 8A-82	MS6	13.0	4021		708		4729	143	140		131
SP 8A-82N	MS6R	13.0	4021		708		4729	143	140		131
SP 8A-91	MS6	15.0	4399		738		5137	143	140		143
SP 8A-91N	MS6R	15.0	4399		738		5137	143	140		143
SP 8A-100	MS6	15.0	4777		738		5515	143	140		150
SP 8A-100N	MS6R	15.0	4777		738		5515	143	140		150
SP 8A-110	MS6	18.5	5197		783		5980	143	140		164
SP 8A-110N	MS6R	18.5	5197		783		5980	143	140		164

E=Maximum diameter of pump inclusive of cable guard and motor.

SP 14A

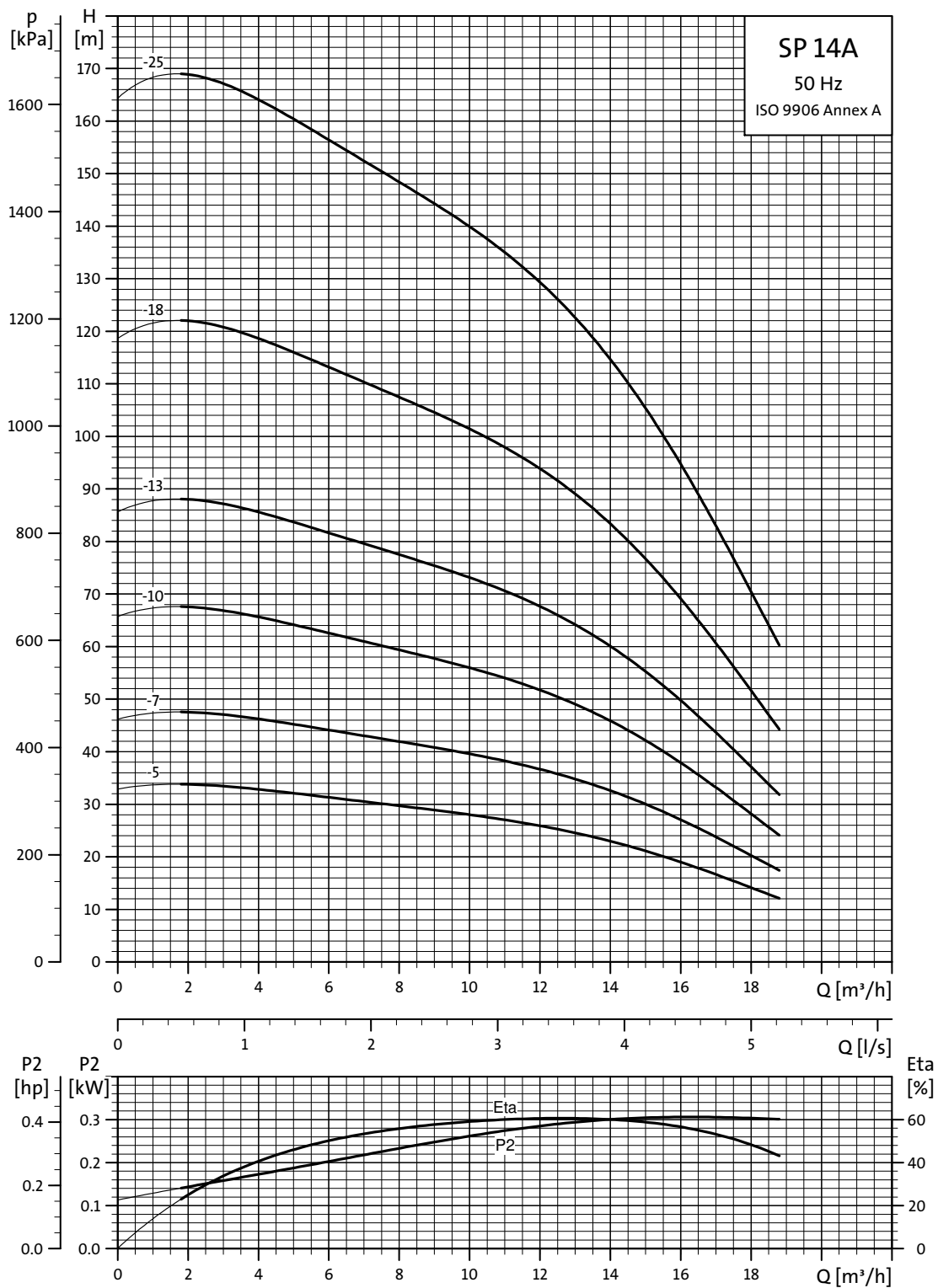

Explanation of efficiency curve, please see *Curve conditions*, page 4.

TM00 7276 4702

Dimensions and weights

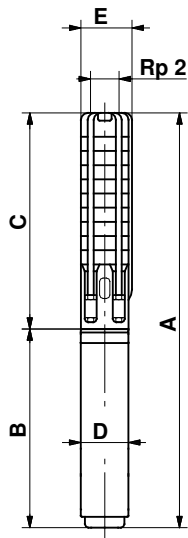

TM00 0957 1196

E = Maximum diameter of pump inclusive of cable guard and motor.

Pump type	Motor		Dimensions [mm]						Net weight [kg]		
	Type	Power [kW]	C	B		A		D	E	Net weight [kg]	
				1x230V	3x230V 3x400V	1x230V	3x230V 3x400V			1x230V	3x230V 3x400V
SP 14A-5	MS 402	1.5	510	346	346	856	856	95	101	18	17
SP 14A-7	MS 4000	2.2	640	573		1213		95	101	29	
SP 14A-7	MS 402	2.2	640	346		986		95	101	19	
SP 14A-10	MS 4000	3.0	835	493		1328		95	101	27	
SP 14A-13	MS 4000	4.0	1030	573		1603		95	101	33	
SP 14A-18	MS 4000	5.5	1355	673		2028		95	101	41	
SP 14A-25	MS 4000	7.5	1810	773		2584		95	101	67	
SP 14A-18	MS6	5.5	1417	535		1952		143	138	52	
SP 14A-25	MS6	7.5	1872	565		2437		143	138	60	

SP 17

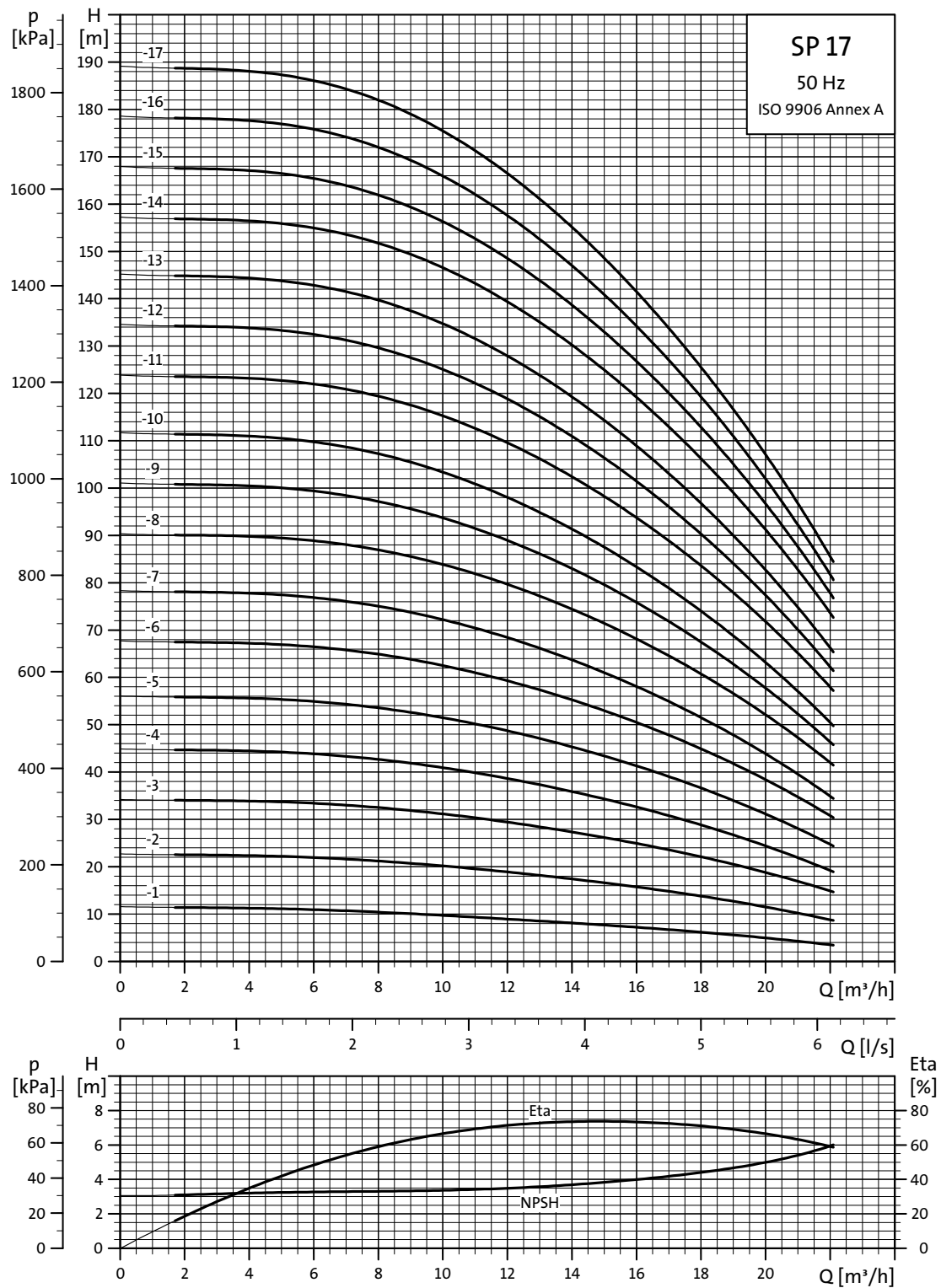

Explanation of efficiency curve, please see *Curve conditions*, page 4.

TMM01 8757 4702

Performance curves

Submersible pumps
SP 17

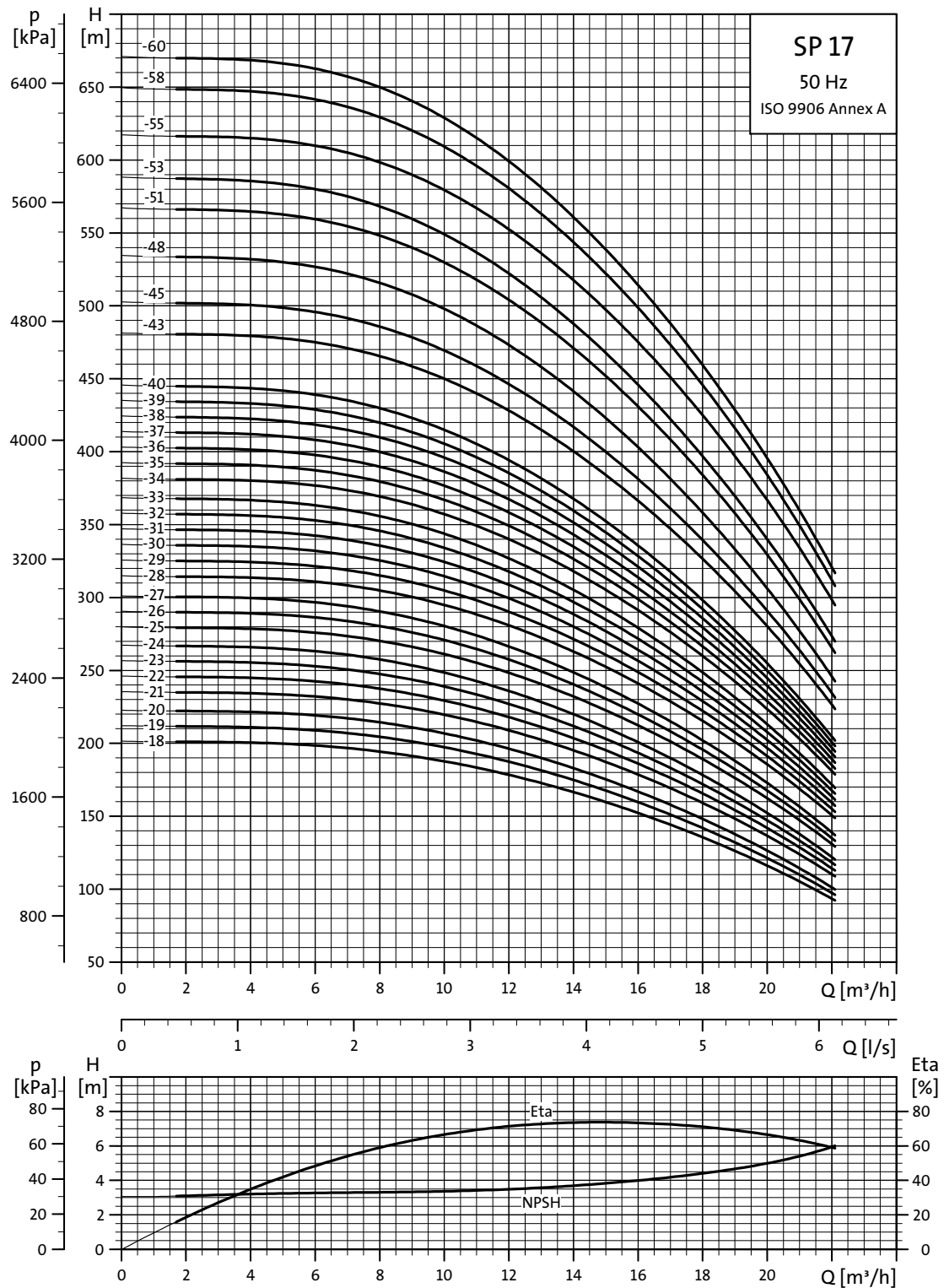

TM01 8758 4702

Explanation of efficiency curve, please see *Curve conditions*, page 4.

Dimensions and weights

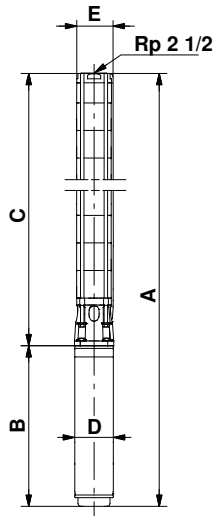

TM01 2435 1798

SP 17-43 to SP 17-60 are mounted in sleeve for R 3 connection.

Pump type	Motor		Dimensions [mm]						Net weight [kg]			
	Type	Power [kW]	C	B		A		D	E*	E**	Net weight [kg]	
				1x230V	3x230V 3x400V	1x230V	3x230V 3x400V				1x230V	3x230V 3x400V
SP 17-1	MS 402	0.55	314	291	241	605	555	95	131	13	11	
SP 17-1 N (R)	MS 4000 R	0.75	314		398		712	95	131		17	
SP 17-1 N (R)	MS 4000 R	2.2	314	573		887		95	131	26		
SP 17-2	MS 402	1.1	374	346	306	720	680	95	131	17	15	
SP 17-2 N (R)	MS 4000 R	1.1	374		413		787	95	131		20	
SP 17-2 N (R)	MS 4000 R	2.2	374	573		947		95	131	27		
SP 17-3	MS 402	2.2	435		346		781	95	131		19	
SP 17-3 N (R)	MS 4000 R	2.2	435	573	453	1008	888	95	131	28	23	
SP 17-4	MS 402	2.2	495		346		841	95	131		20	
SP 17-4	MS 4000	2.2	495	573	453	1068	948	95	131	29	24	
SP 17-5	MS 4000	3.0	556		494		1050	95	131		26	
SP 17-6	MS 4000	4.0	616		574		1190	95	131		31	
SP 17-7	MS 4000	4.0	677		574		1251	95	131		33	
SP 17-8	MS 4000	5.5	737		674		1411	95	131		39	
SP 17-9	MS 4000	5.5	798		674		1472	95	131		40	
SP 17-10	MS 4000	5.5	858		674		1532	95	131		41	
SP 17-11	MS 4000	7.5	919		773		1692	95	131		47	
SP 17-12	MS 4000	7.5	979		773		1752	95	131		49	
SP 17-13	MS 4000	7.5	1040		773		1813	95	131		50	
SP 17-8	MS6	5.5	753		535		1288	143	142	142	50	
SP 17-9	MS6	5.5	814		535		1349	143	142	142	51	
SP 17-10	MS6	5.5	874		535		1409	143	142	142	53	
SP 17-11	MS6	7.5	935		565		1500	143	142	142	55	
SP 17-12	MS6	7.5	995		565		1560	143	142	142	56	
SP 17-13	MS6	7.5	1056		565		1621	143	142	142	57	
SP 17-14	MS6	9.2	1116		590		1706	143	142	142	64	
SP 17-15	MS6	9.2	1177		590		1767	143	142	142	65	
SP 17-16	MS6	9.2	1237		590		1827	143	142	142	66	
SP 17-17	MS6	9.2	1298		590		1888	143	142	142	67	
SP 17-18	MS6	11	1358		683		2041	143	142	142	72	
SP 17-19	MS6	11	1419		683		2102	143	142	142	73	
SP 17-20	MS6	11	1479		683		2162	143	142	142	74	
SP 17-21	MS6	13	1540		708		2248	143	142	142	78	
SP 17-22	MS6	13	1600		708		2308	143	142	142	79	
SP 17-23	MS6	13	1661		708		2369	143	142	142	81	
SP 17-24	MS6	13	1721		708		2429	143	142	142	82	
SP 17-25	MS6	15	1782		738		2520	143	142	142	87	
SP 17-26	MS6	15	1842		738		2580	143	142	142	88	
SP 17-27	MS6	15	1903		738		2641	143	142	142	89	
SP 17-28	MS6	18.5	1963		783		2746	143	142	142	96	
SP 17-29	MS6	18.5	2024		783		2807	143	142	142	97	
SP 17-30	MS6	18.5	2084		783		2867	143	142	142	99	
SP 17-31	MS6	18.5	2145		783		2928	143	142	142	100	
SP 17-32	MS6	18.5	2205		783		2988	143	142	142	101	
SP 17-33	MS6	18.5	2266		783		3049	143	142	142	102	
SP 17-34	MS6	22	2326		838		3164	143	142	142	109	
SP 17-35	MS6	22	2387		838		3225	143	142	142	111	
SP 17-36	MS6	22	2447		838		3285	143	142	142	112	
SP 17-37	MS6	22	2508		838		3346	143	142	142	113	
SP 17-38	MS6	22	2568		838		3406	143	142	142	114	
SP 17-39	MS6	22	2629		838		3467	143	142	142	115	
SP 17-40	MS6	22	2689		838		3527	143	142	142	117	
SP 17-43	MS6	26	3118		903		4021	143	175	181	164	
SP 17-45	MS6	26	3239		903		4142	143	175	181	167	
SP 17-48	MS6	26	3420		903		4323	143	175	181	172	
SP 17-51	MS6	30	3602		968		4570	143	175	181	185	
SP 17-53	MS6	30	3723		968		4691	143	175	181	189	
SP 17-55	MMS 6000	37	3844		1425		5269	144	175	181	239	
SP 17-58	MMS 6000	37	4025		1425		5450	144	175	181	244	
SP 17-60	MMS 6000	37	4146		1425		5571	144	175	181	248	
SP 17-55	MMS6	37	3844		1312		5156	143	175	181	234	
SP 17-58	MMS6	37	4025		1312		5337	143	175	181	239	
SP 17-60	MMS6	37	4146		1312		5458	143	175	181	243	

* Maximum diameter of pump with one motor cable

** Maximum diameter of pump with two motor cables.

The pump types above are also available in R- and N-versions. See page 5. Dimensions as above.

Other types of connection are possible by means of connecting pieces. See page 87

Power curves

Submersible pumps
SP 17

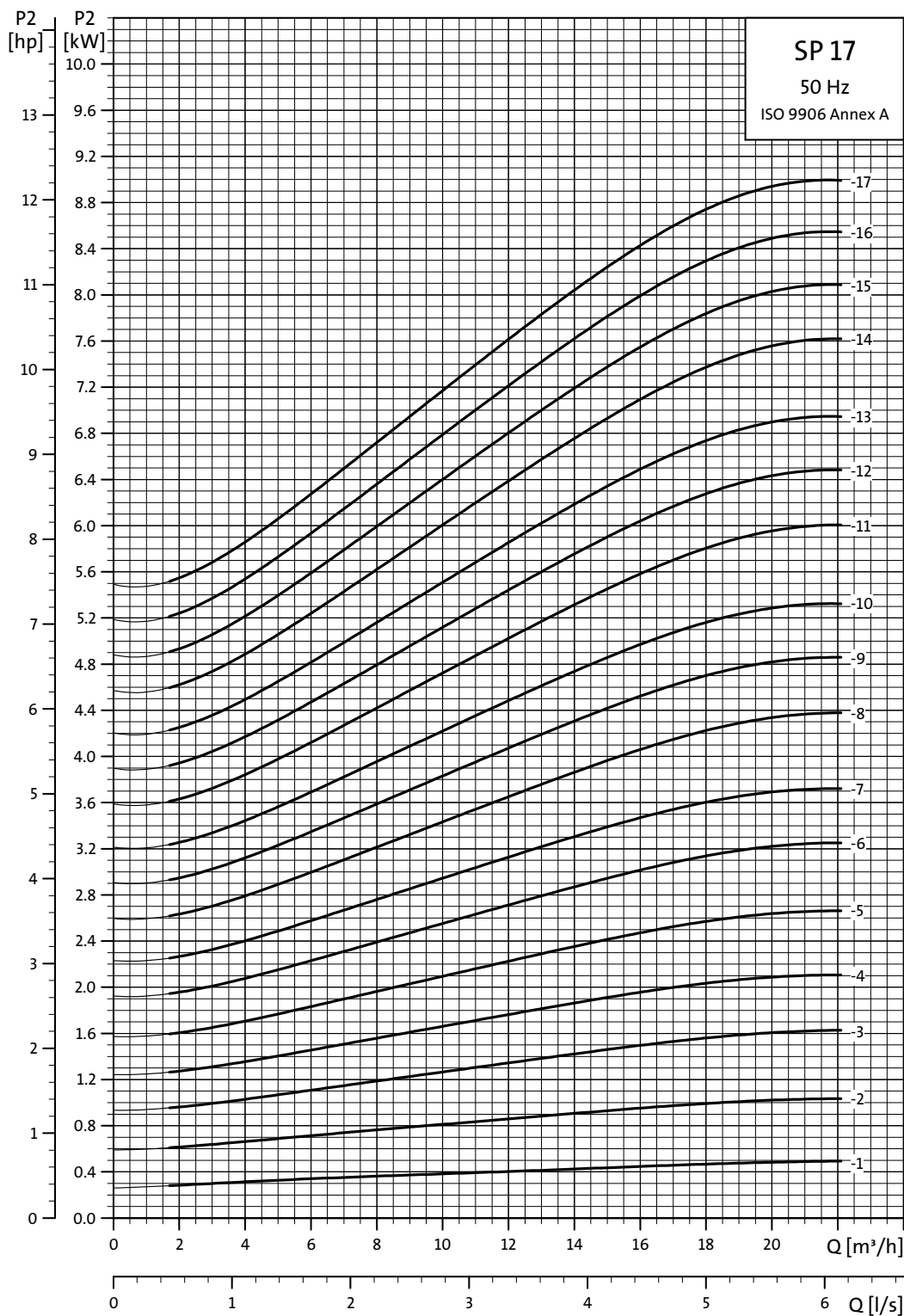

TM01 8759 4702

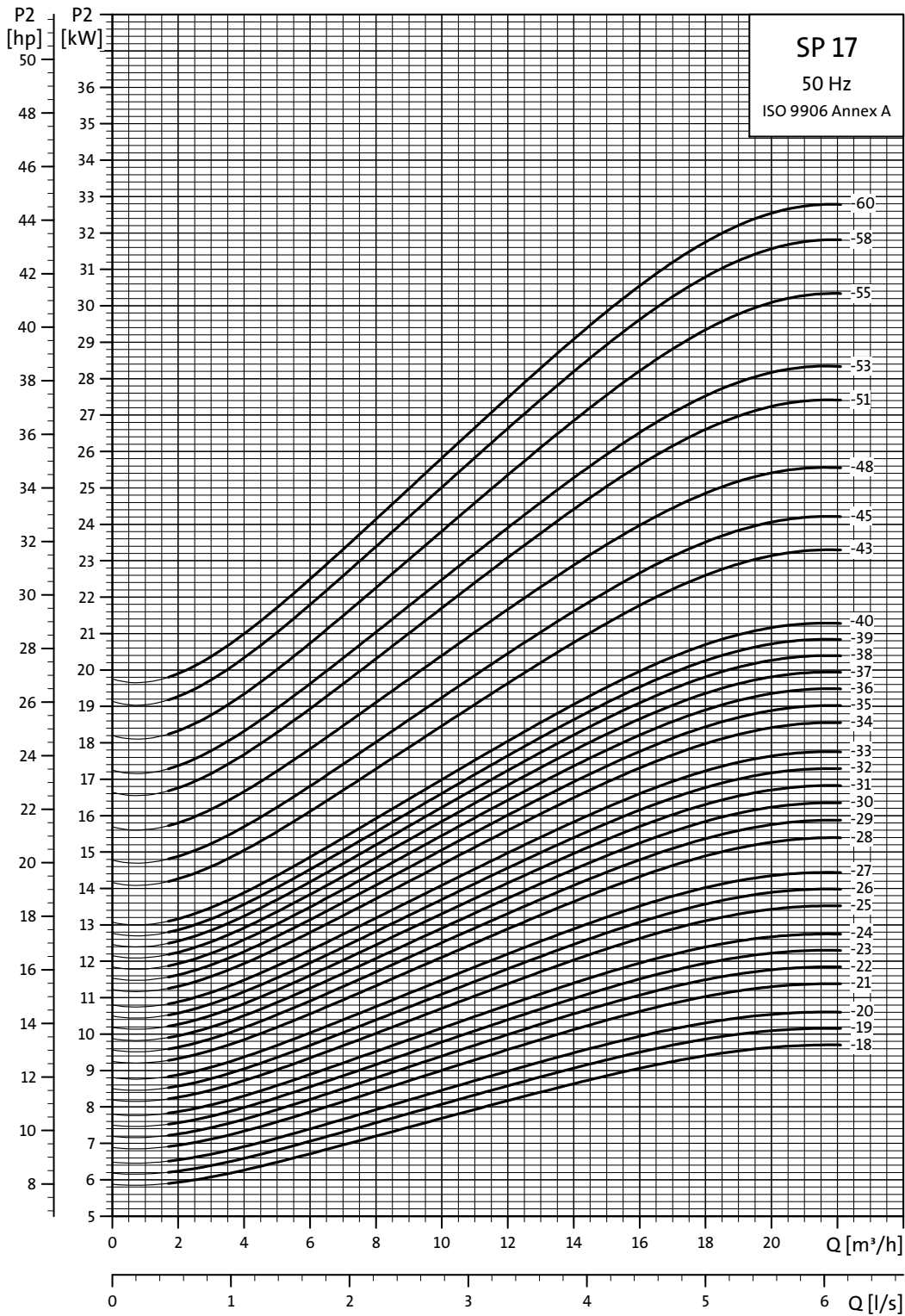

TM01 8760 4702

Performance curves

Submersible pumps
SP 30

SP 30

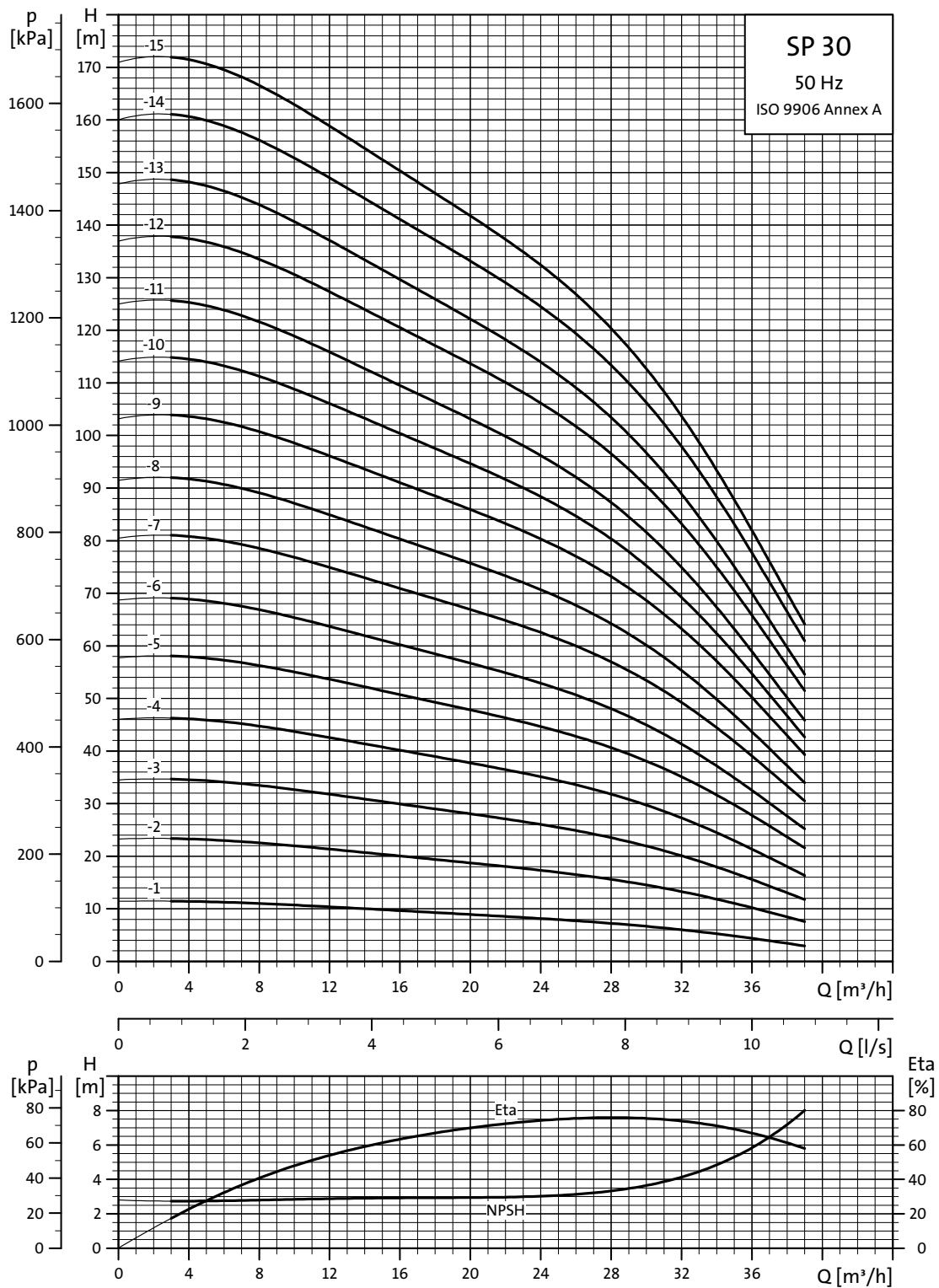

TMD01 8761 4702

Explanation of efficiency curve, please see *Curve conditions*, page 4.

Performance curves

Submersible pumps
SP 30

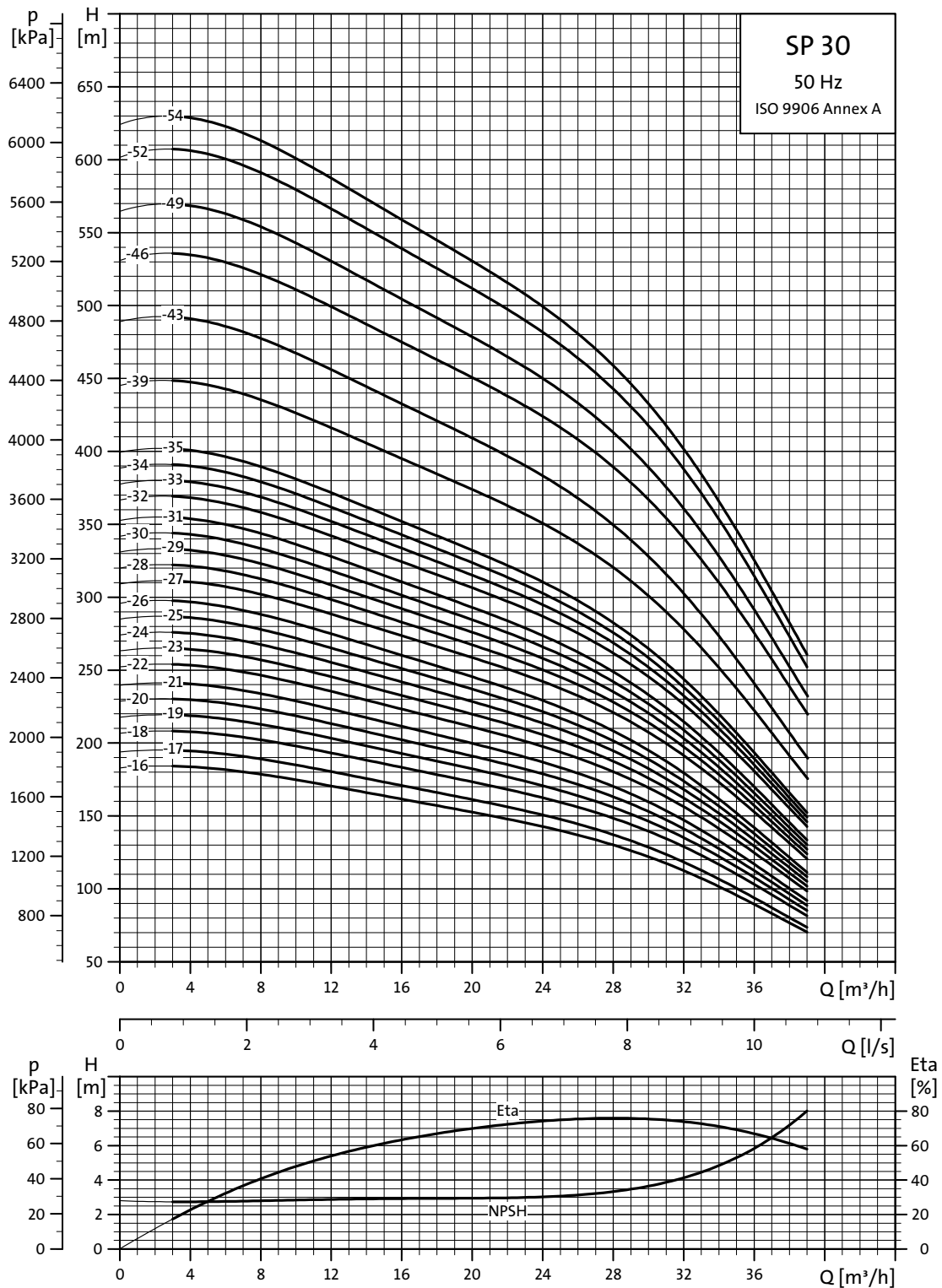

TM01 8762 4702

Explanation of efficiency curve, please see *Curve conditions*, page 4.

Dimensions and weights

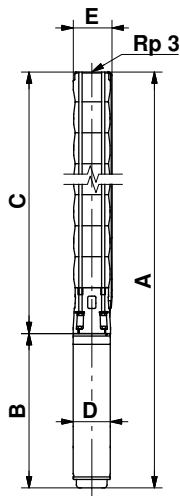

TN00 0960 1196

SP 30-39 to SP 30-54 are mounted in sleeve for R 3 connection.

Pump type	Motor		Dimensions [mm]						Net weight [kg]			
	Type	Power [kW]	C	B		A		D	E*	E**	Net weight [kg]	
				1x230V	3x23V 3x400V	1x230V	3x230V 3x400V				1x230V	3x230V 3x400V
SP 30-1	MS 402	1.1	349	346	306	695	655	95	131		16	14
SP 30-1 N (R)	MS 4000 R	2.2	349	573		922		95	131		26	
SP 30-2	MS 402	2.2	445		346		791	95	131			19
SP 30-2 N (R)	MS 4000 R	2.2	445	573	453	1018	898	95	131		28	23
SP 30-3	MS 4000	3.0	541		494		1035	95	131			25
SP 30-4	MS 4000	4.0	637		574		1211	95	131			31
SP 30-5	MS 4000	5.5	733		674		1407	95	131			38
SP 30-6	MS 4000	5.5	829		674		1503	95	131			39
SP 30-7	MS 4000	7.5	925		773		1698	95	131			46
SP 30-8	MS 4000	7.5	1021		773		1794	95	131			48
SP 30-5	MS6	5.5	749		535		1284	143	142	142		49
SP 30-6	MS6	5.5	845		535		1380	143	142	142		51
SP 30-7	MS6	7.5	941		565		1506	143	142	142		53
SP 30-8	MS6	7.5	1037		565		1602	143	142	142		55
SP 30-9	MS6	9.2	1133		590		1723	143	142	142		62
SP 30-10	MS6	9.2	1229		590		1819	143	142	142		64
SP 30-11	MS6	9.2	1325		590		1915	143	142	142		65
SP 30-12	MS6	11	1421		683		2104	143	142	142		70
SP 30-13	MS6	11	1517		683		2200	143	142	142		72
SP 30-14	MS6	13	1613		708		2321	143	142	142		76
SP 30-15	MS6	13	1709		708		2417	143	142	142		78
SP 30-16	MS6	15	1805		738		2543	143	142	142		84
SP 30-17	MS6	15	1901		738		2639	143	142	142		85
SP 30-18	MS6	18.5	1997		783		2780	143	142	142		93
SP 30-19	MS6	18.5	2093		783		2876	143	142	142		94
SP 30-20	MS6	18.5	2189		783		2972	143	142	142		96
SP 30-21	MS6	18.5	2285		783		3068	143	142	142		98
SP 30-22	MS6	22	2381		838		3219	143	142	142		105
SP 30-23	MS6	22	2477		838		3315	143	142	142		107
SP 30-24	MS6	22	2573		838		3411	143	142	142		109
SP 30-25	MS6	22	2669		838		3507	143	142	142		110
SP 30-26	MS6	22	2765		838		3603	143	142	142		112
SP 30-27	MS6	26	2861		903		3764	143	142	142		119
SP 30-28	MS6	26	2957		903		3860	143	142	142		121
SP 30-29	MS6	26	3053		903		3956	143	142	142		123
SP 30-30	MS6	26	3149		903		4052	143	142	142		124
SP 30-31	MS6	26	3245		903		4148	143	142	142		126
SP 30-32	MS6	30	3341		968		4309	143	144	145		136
SP 30-33	MS6	30	3437		968		4405	143	144	145		137
SP 30-34	MS6	30	3533		968		4501	143	144	145		139
SP 30-35	MS6	30	3629		968		4597	143	144	145		141
SP 30-39	MMS 6000	37	4260		1425		5685	144	175	181		253
SP 30-43	MMS 6000	37	4644		1425		6069	144	175	181		264
SP 30-39	MMS6	37	4260		1312		5572	143	175	181		248
SP 30-43	MMS6	37	4644		1312		5956	143	175	181		259
SP 30-46	MMS 8000	45	4881		1270		6151	192	175	181		325
SP 30-49	MMS 8000	45	5169		1270		6439	192	175	181		332
SP 30-52	MMS 8000	55	5457		1350		6807	192	192	192		357
SP 30-54	MMS 8000	55	5649		1350		6999	192	192	192		362

* Maximum diameter of pump with one motor cable.

** Maximum diameter of pump with two motor cables.

The pump types above are also available in R- and N-versions. See page 5. Dimensions as above. Other types of connection are possible by means of connecting pieces. See page 87.

Power curves

Submersible pumps
SP 30

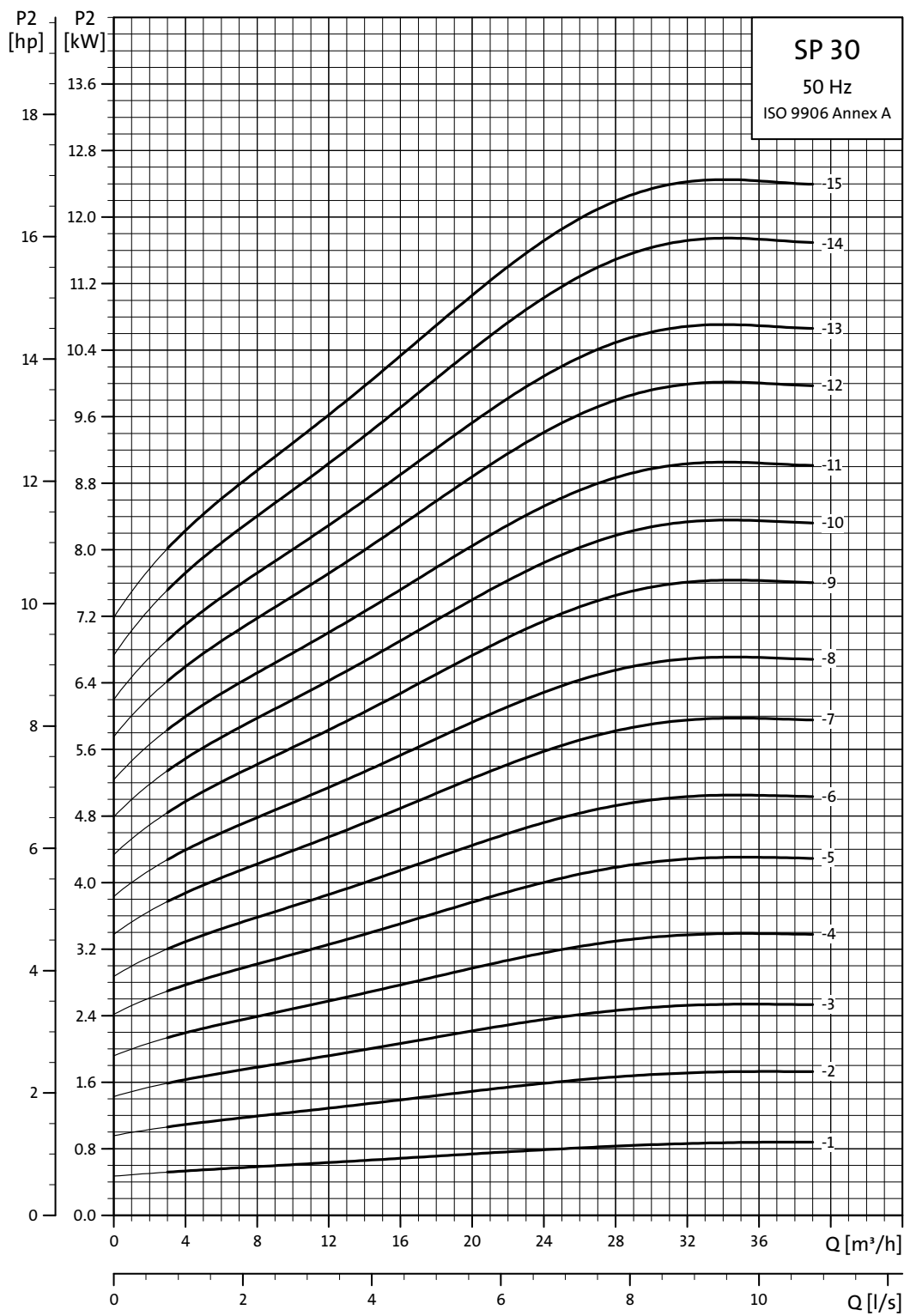

TM01 8763 4702

Power curves

Submersible pumps
SP 30

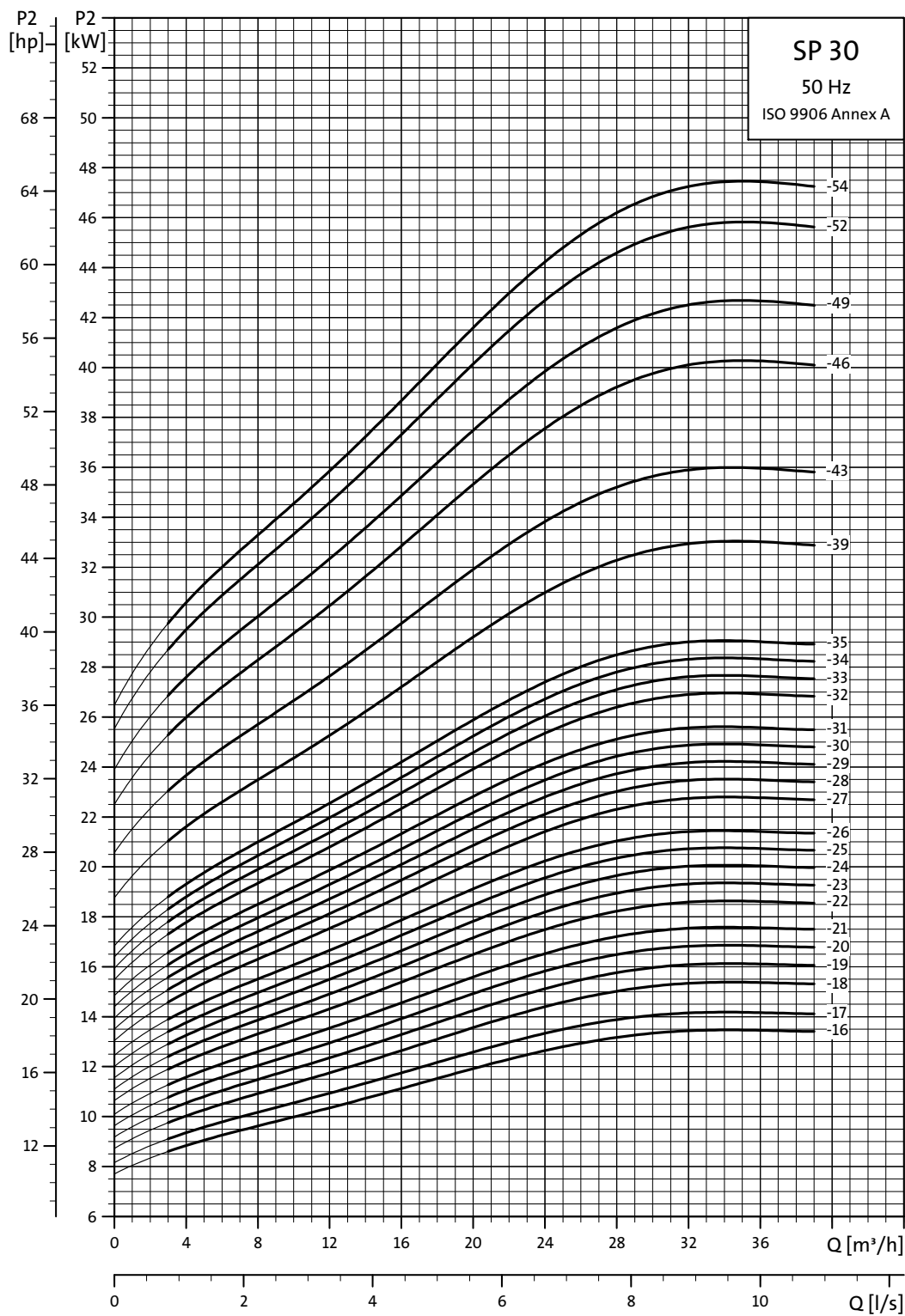

TM01 8764 4702

SP 46

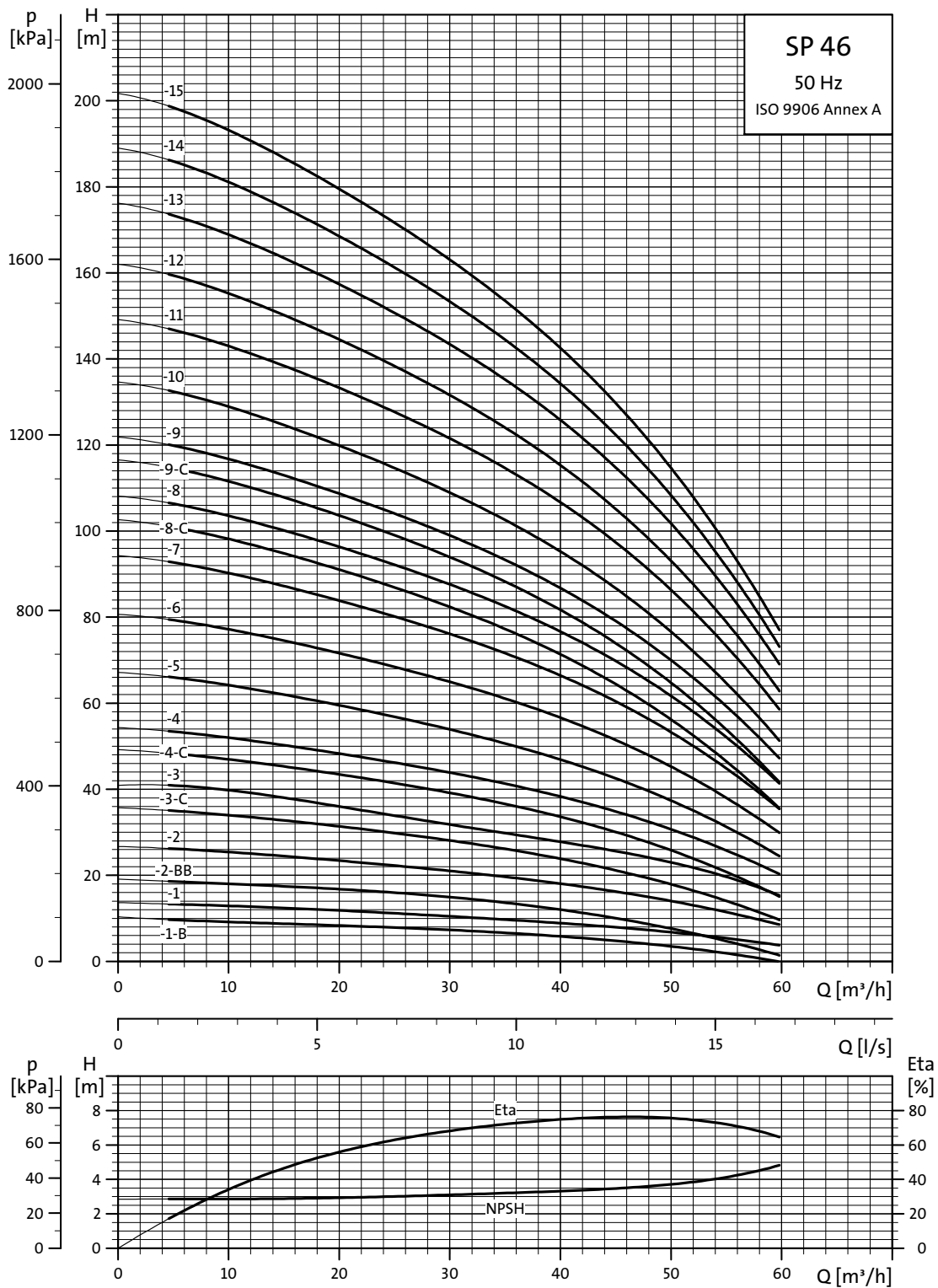

Explanation of efficiency curve, please see *Curve conditions*, page 4.

TM01 8765 4702

Performance curves

Submersible pumps
SP 46

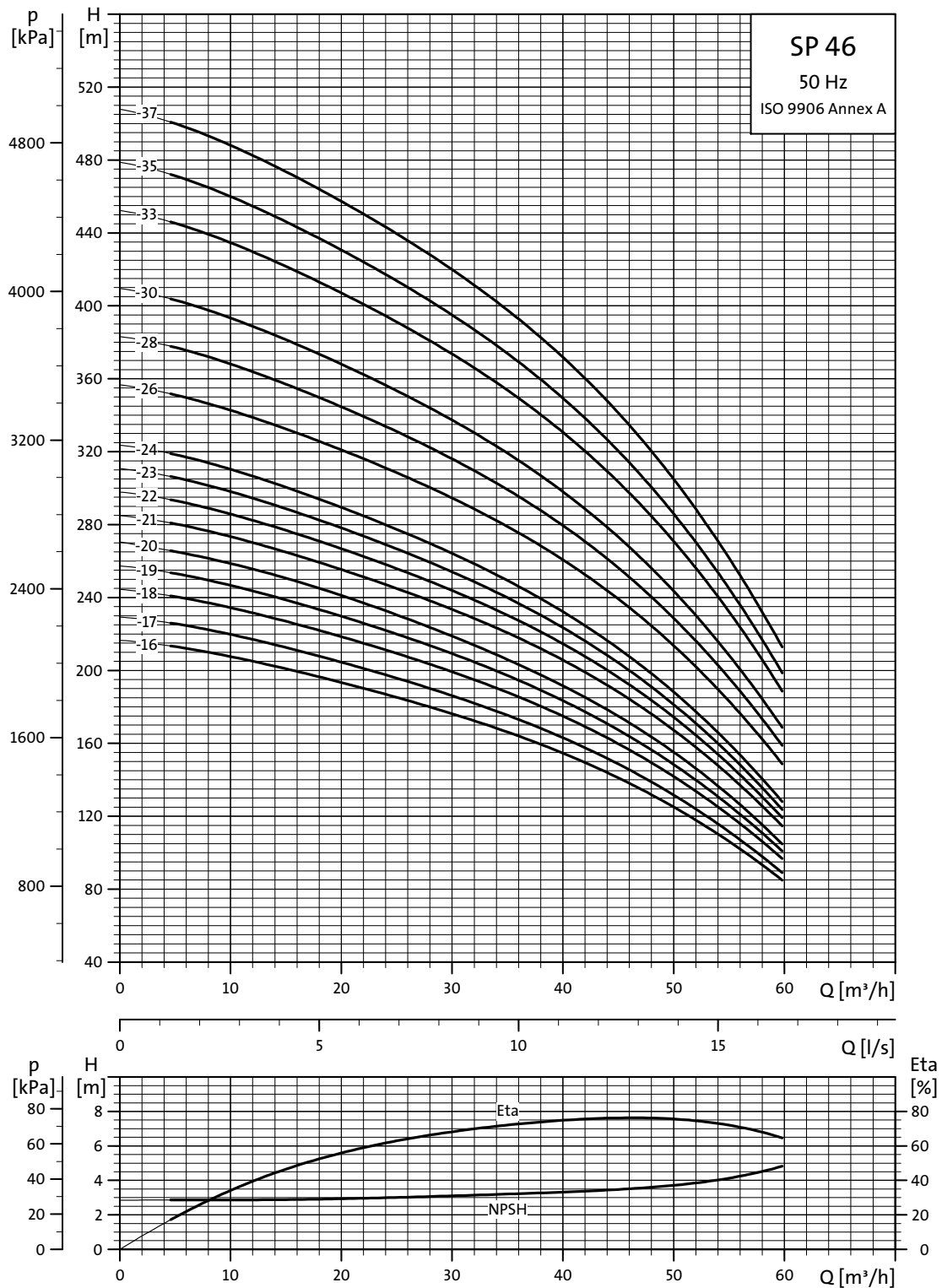

TM01 8766 4702

Explanation of efficiency curve, please see *Curve conditions*, page 4.

Dimensions and weights

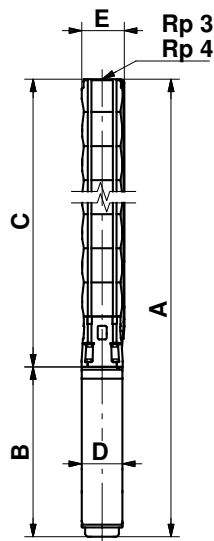

SP 46-26 to SP 46-37 are mounted in sleeve for R 4 connection.

TM00 0961 1196

Pump type	Motor		Dimensions [mm]								Net weight [kg]
	Type	Power [kW]	Rp 3 connection				Rp 4 connection				
			A	C	E*	E**	A	C	E*	E**	
SP 46-1-B	MS 4000	1.1	777	364	141	783	370	145	413	95	20
SP 46-1	MS 4000	2.2	817	364	141	823	370	145	453	95	22
SP 46-2-BB	MS 4000	2.2	930	477	141	936	483	145	453	95	24
SP 46-2	MS 4000	3.0	970	477	141	976	483	145	493	95	25
SP 46-3-C	MS 4000	4.0	1163	590	141	1169	596	145	573	95	32
SP 46-3	MS 4000	5.5	1263	590	141	1269	596	145	673	95	37
SP 46-4-C	MS 4000	5.5	1376	703	141	1382	709	145	673	95	39
SP 46-4	MS 4000	7.5	1476	703	141	1482	709	145	773	95	44
SP 46-5	MS 4000	7.5	1589	816	141	1595	822	145	773	95	47
SP 46-3	MS6	5.5	1141	606	145	1147	612	147	535	143	48
SP 46-4	MS6	7.5	1284	719	145	1290	725	147	565	143	52
SP 46-5	MS6	7.5	1397	832	145	1403	838	147	565	143	54
SP 46-6	MS6	9.2	1535	945	145	1541	951	147	590	143	62
SP 46-7	MS6	11	1741	1058	145	1747	1064	147	683	143	68
SP 46-8-C	MS6	11	1854	1171	145	1860	1177	147	683	143	70
SP 46-8	MS6	13	1879	1171	145	1885	1177	147	708	143	73
SP 46-9-C	MS6	13	1992	1284	145	1998	1290	147	708	143	76
SP 46-9	MS6	15	2022	1284	145	2028	1290	147	738	143	80
SP 46-10	MS6	15	2135	1397	145	2141	1403	147	738	143	82
SP 46-11	MS6	18.5	2293	1510	145	2299	1516	147	783	143	90
SP 46-12	MS6	18.5	2406	1623	145	2412	1629	147	783	143	93
SP 46-13	MS6	22	2574	1736	145	2580	1742	147	838	143	101
SP 46-14	MS6	22	2687	1849	145	2693	1855	147	838	143	104
SP 46-15	MS6	22	2800	1962	145	2806	1968	147	838	143	106
SP 46-16	MS6	26	2978	2075	145	2984	2081	147	903	143	114
SP 46-17	MS6	26	3091	2188	145	3097	2194	147	903	143	117
SP 46-18	MS6	30	3269	2301	145	3275	2307	147	968	143	128
SP 46-19	MS6	30	3382	2414	145	3388	2420	147	968	143	130
SP 46-20	MS6	30	3575	2607	145	3581	2613	147	968	143	132
SP 46-21	MMS 6000	37	4145	2720	145	4151	2726	147	1425	144	185
SP 46-22	MMS 6000	37	4258	2833	145	4264	2839	147	1425	144	188
SP 46-23	MMS 6000	37	4371	2946	145	4377	2952	147	1425	144	190
SP 46-24	MMS 6000	37	4484	3059	145	4490	3065	147	1425	144	193
SP 46-21	MMS6	37	4032	2720	145	4038	2726	147	1312	143	180
SP 46-22	MMS6	37	4145	2833	145	4151	2839	147	1312	143	183
SP 46-23	MMS6	37	4258	2946	145	4264	2952	147	1312	143	185
SP 46-24	MMS6	37	4371	3059	145	4377	3065	147	1312	143	188
SP 46-26	MMS 8000	45				4673	3403	192	1270	192	278
SP 46-28	MMS 8000	45				4899	3629	192	1270	192	284
SP 46-30	MMS 8000	45				5125	3855	192	1270	192	290
SP 46-33	MMS 8000	55				5544	4194	192	1350	192	314
SP 46-35	MMS 8000	55				5770	4420	192	1350	192	319
SP 46-37	MMS 8000	63				6136	4646	192	1490	192	351

* Maximum diameter of pump with one motor cable.

** Maximum diameter of pump with two motor cables.

The pump types above are also available in R- and N-versions. See page 5.

Pumps in R-versions are available up to and incl. SP 46-24, i.e. sleeve versions. Dimensions as above.

Other types of connection are possible by means of connecting pieces. See page 87.

Power curves

Submersible pumps
SP 46

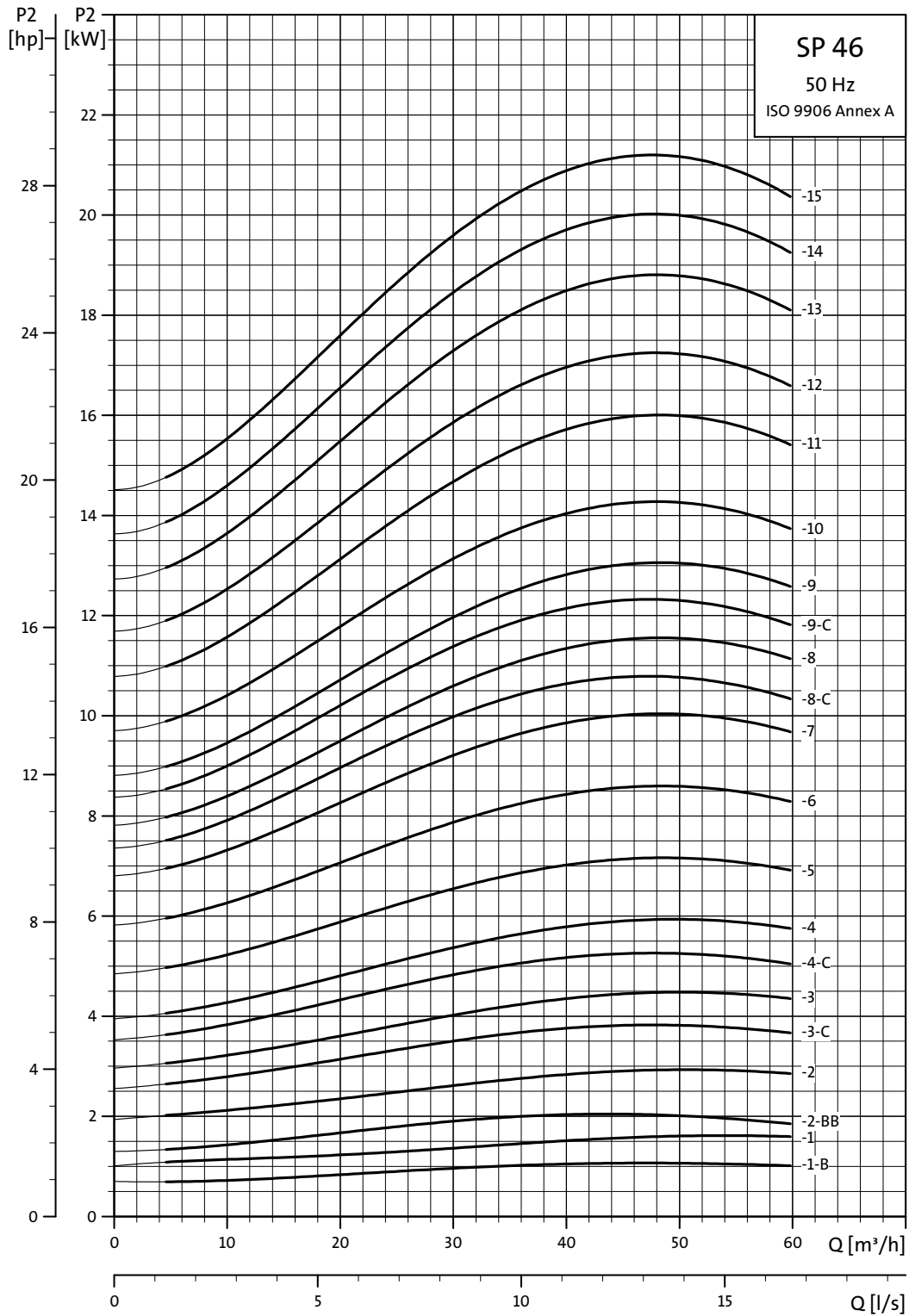

TM01 8767 4702

Power curves

Submersible pumps
SP 46

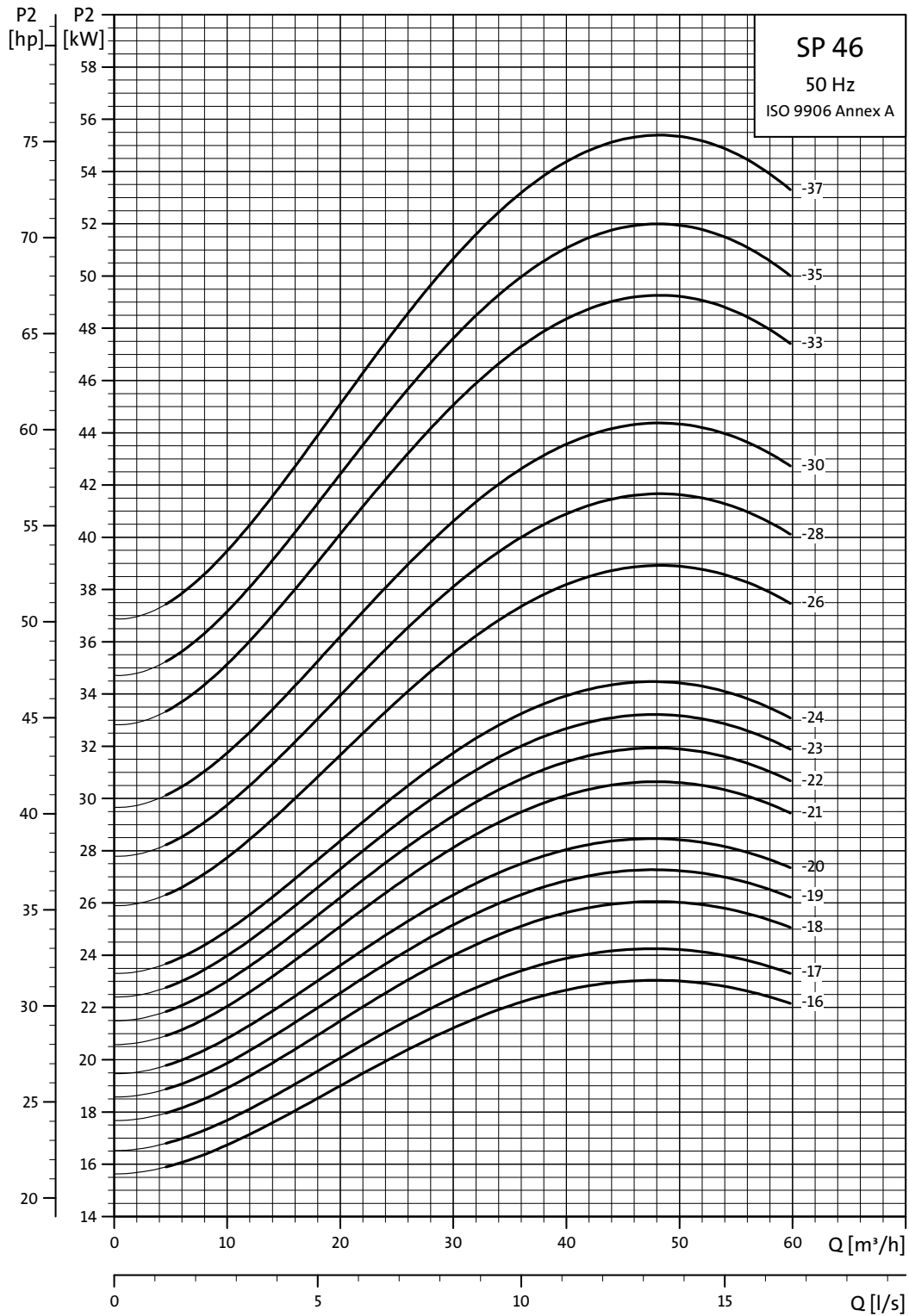

TM01 8768 4702

SP 60

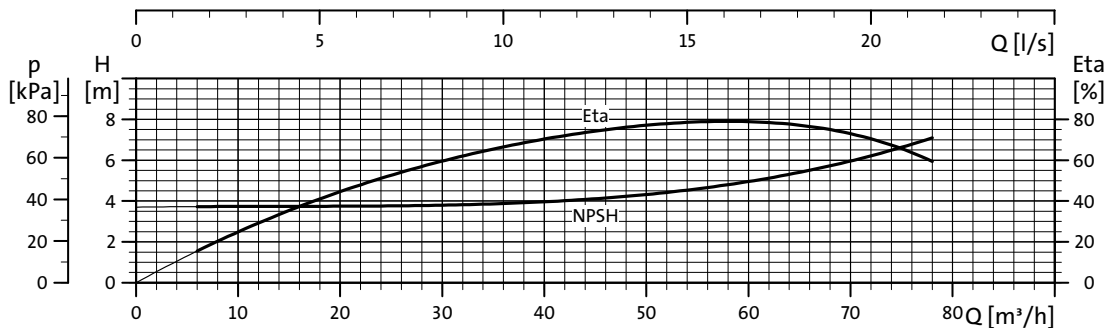
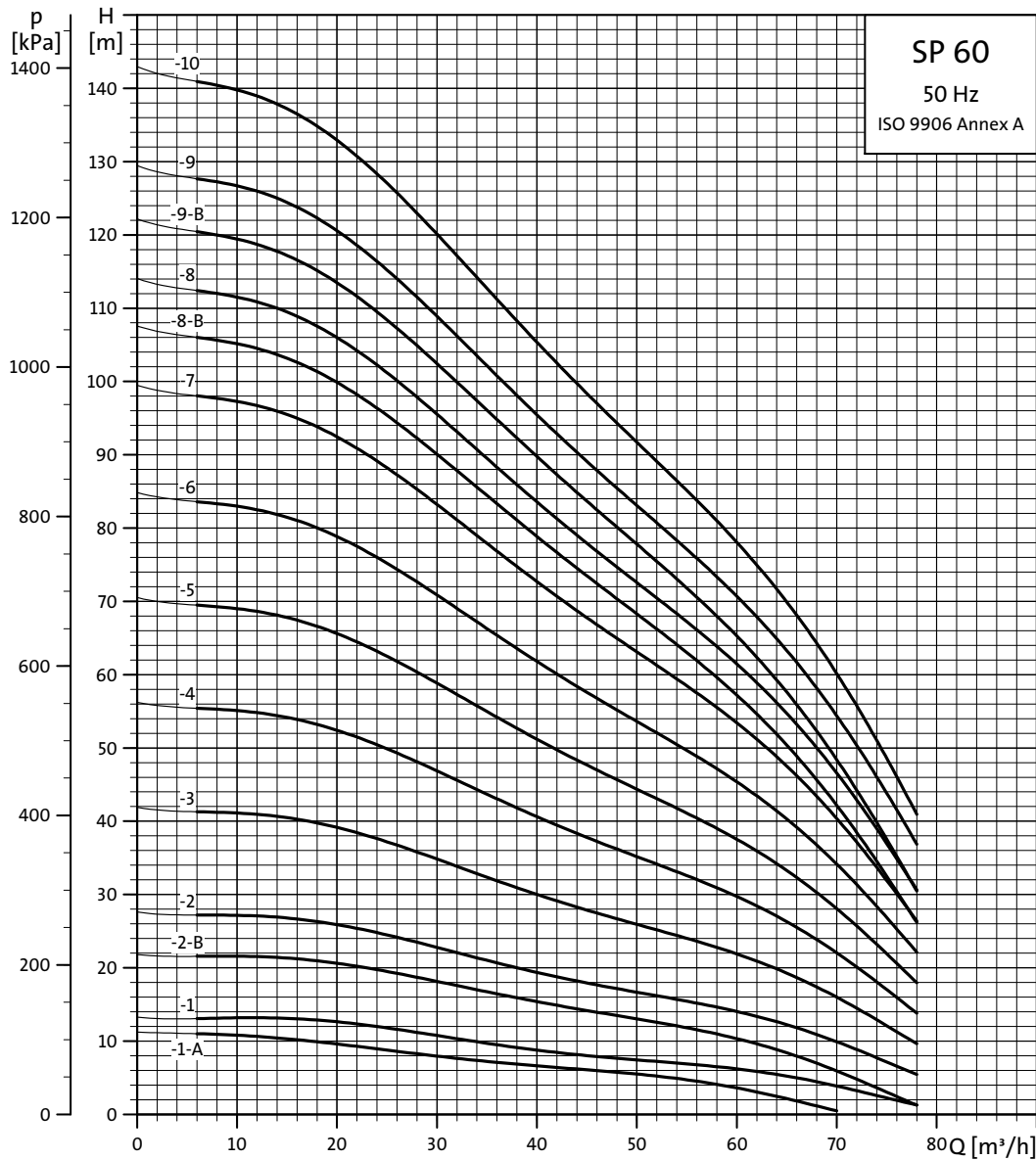

Explanation of efficiency curve, please see *Curve conditions*, page 4.

TM01 8826 4702

Performance curves

Submersible pumps
SP 60

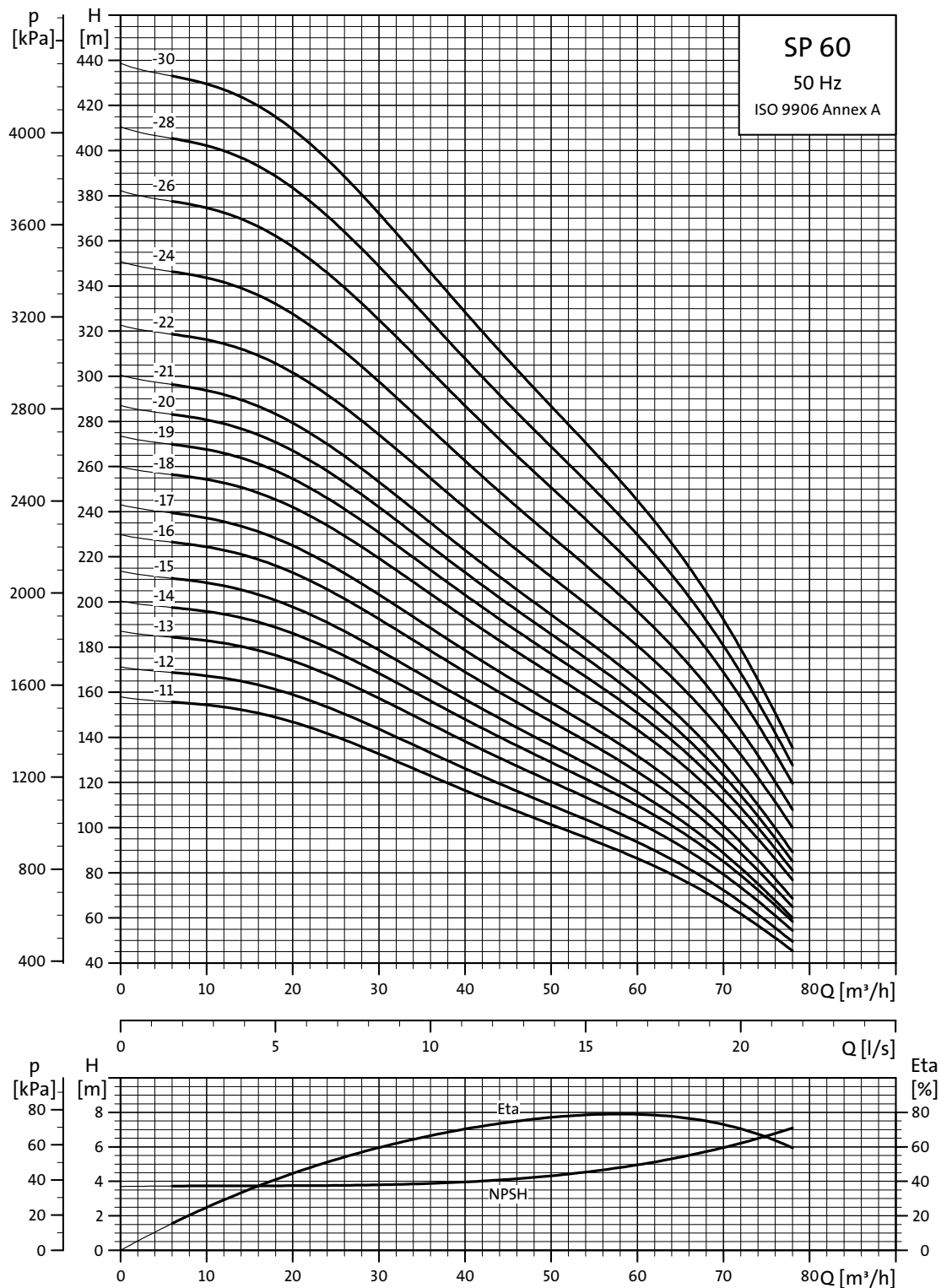

TM01 8827 4702

Explanation of efficiency curve, please see *Curve conditions*, page 4.

Dimensions and weights

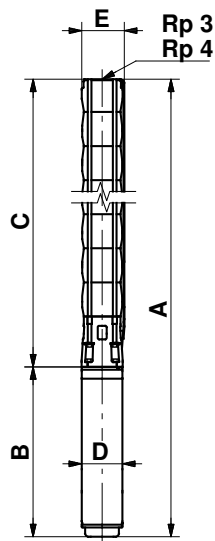

TM00 0961 1196

Pump type	Motor		Dimensions [mm]								B	D	Net weight [kg]	
	Type	Power [kW]	Rp 3 connection				Rp 4 connection							
			A	C	E*	E**	A	C	E*	E**				
SP 60-1-A	MS 4000	1.5	780	364	142			786	370	146	416	95	20	
SP 60-1	MS 4000	2.2	817	364	142			823	370	146	453	95	22	
SP 60-2-B	MS 4000	3.0	970	477	142			976	483	146	493	95	25	
SP 60-2	MS 4000	4.0	1050	477	142			1056	483	146	573	95	29	
SP 60-3	MS 4000	5.5	1263	590	142			1269	596	146	673	95	37	
SP 60-3	MS6	5.5	1141	606	147	150		1147	612	149	152	535	138	47
SP 60-4	MS 4000	7.5	1476	703	142			1482	709	146	773	95	44	
SP 60-4	MS6	7.5	1284	719	147	150		1290	725	149	152	565	143	50
SP 60-5	MS6	9.2	1422	832	147	150		1428	838	149	152	590	143	60
SP 60-6	MS6	11	1633	950	147	150		1634	951	149	152	683	143	65
SP 60-7	MS6	13	1766	1058	147	150		1772	1064	149	152	708	143	71
SP 60-8-B	MS6	13	1879	1171	147	150		1885	1177	149	152	708	143	73
SP 60-8	MS6	15	1909	1171	147	150		1915	1177	149	152	738	143	77
SP 60-9-B	MS6	15	2022	1284	147	150		2028	1290	149	152	738	143	80
SP 60-9	MS6	18.5	2067	1284	147	150		2073	1290	149	152	783	143	85
SP 60-10	MS6	18.5	2180	1397	147	150		2186	1403	149	152	783	143	88
SP 60-11	MS6	22	2348	1510	147	150		2354	1516	149	152	838	143	96
SP 60-12	MS6	22	2461	1623	147	150		2467	1629	149	152	838	143	99
SP 60-13	MS6	26	2639	1736	147	150		2645	1742	149	152	903	143	107
SP 60-14	MS6	26	2752	1849	147	150		2758	1855	149	152	903	143	109
SP 60-15	MS6	26	2865	1962	147	150		2871	1968	149	152	903	143	112
SP 60-16	MS6	30	3043	2075	147	150		3049	2081	149	152	968	143	122
SP 60-17	MS6	30	3156	2188	147	150		3162	2194	152	156	968	143	125
SP 60-18	MMS 6000	37	3806	2381	150	154		3812	2387	152	156	1425	144	178
SP 60-19	MMS 6000	37	3919	2494	150	154		3925	2500	152	156	1425	144	180
SP 60-20	MMS 6000	37	4032	2607	150	154		4038	2613	152	156	1425	144	183
SP 60-21	MMS 6000	37	4147	2722	150	154		4151	2726	152	156	1425	144	185
SP 60-18	MMS6	37	3693	2381	150	154		3699	2387	152	156	1312	143	173
SP 60-19	MMS6	37	3806	2494	150	154		3812	2500	152	156	1312	143	175
SP 60-20	MMS6	37	3919	2607	150	154		3925	2613	152	156	1312	143	178
SP 60-21	MMS6	37	4034	2722	150	154		4038	2726	152	156	1312	143	180
SP 60-22	MMS 8000	45	4054	2784	180	180		4058	2788	180	180	1270	192	239
SP 60-24	MMS 8000	45						4447	3177	193	195	1270	192	272
SP 60-26	MMS 8000	55						4753	3403	193	195	1350	192	293
SP 60-28	MMS 8000	55						4979	3629	193	195	1350	192	299
SP 60-30	MMS 8000	55						5205	3855	193	195	1350	192	305

* Maximum diameter of pump with one motor cable.

** Maximum diameter of pump with two motor cables.

The pump types above are also available in R- and N-versions. See page 5.

Pumps in R-versions are available up to and incl. SP 60-22, i.e. sleeve versions. Dimensions as above.

Other types of connection are possible by means of connecting pieces. See page 87.

Power curves

Submersible pumps
SP 60

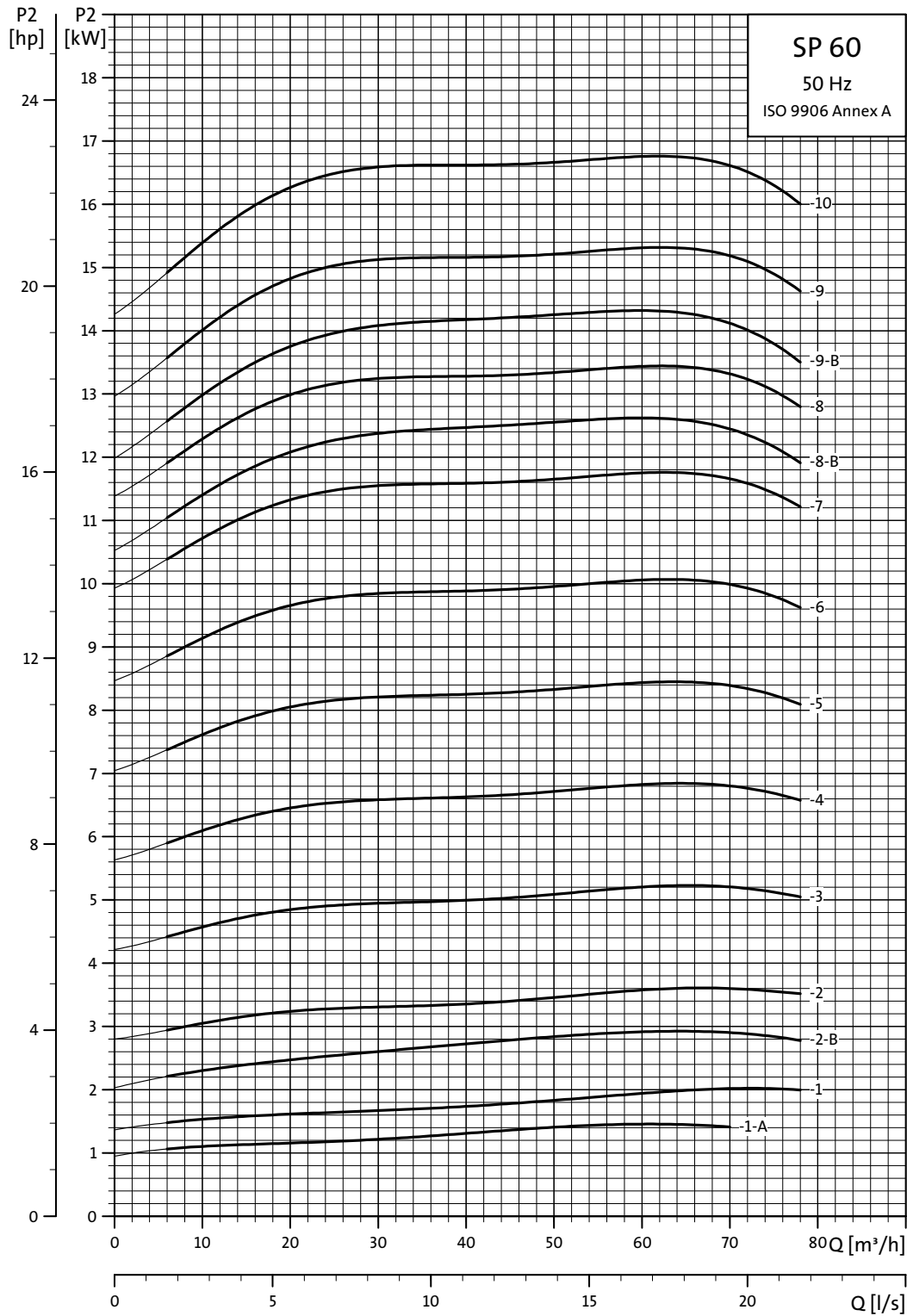

TM01 8828 4702

Power curves

Submersible pumps
SP 60

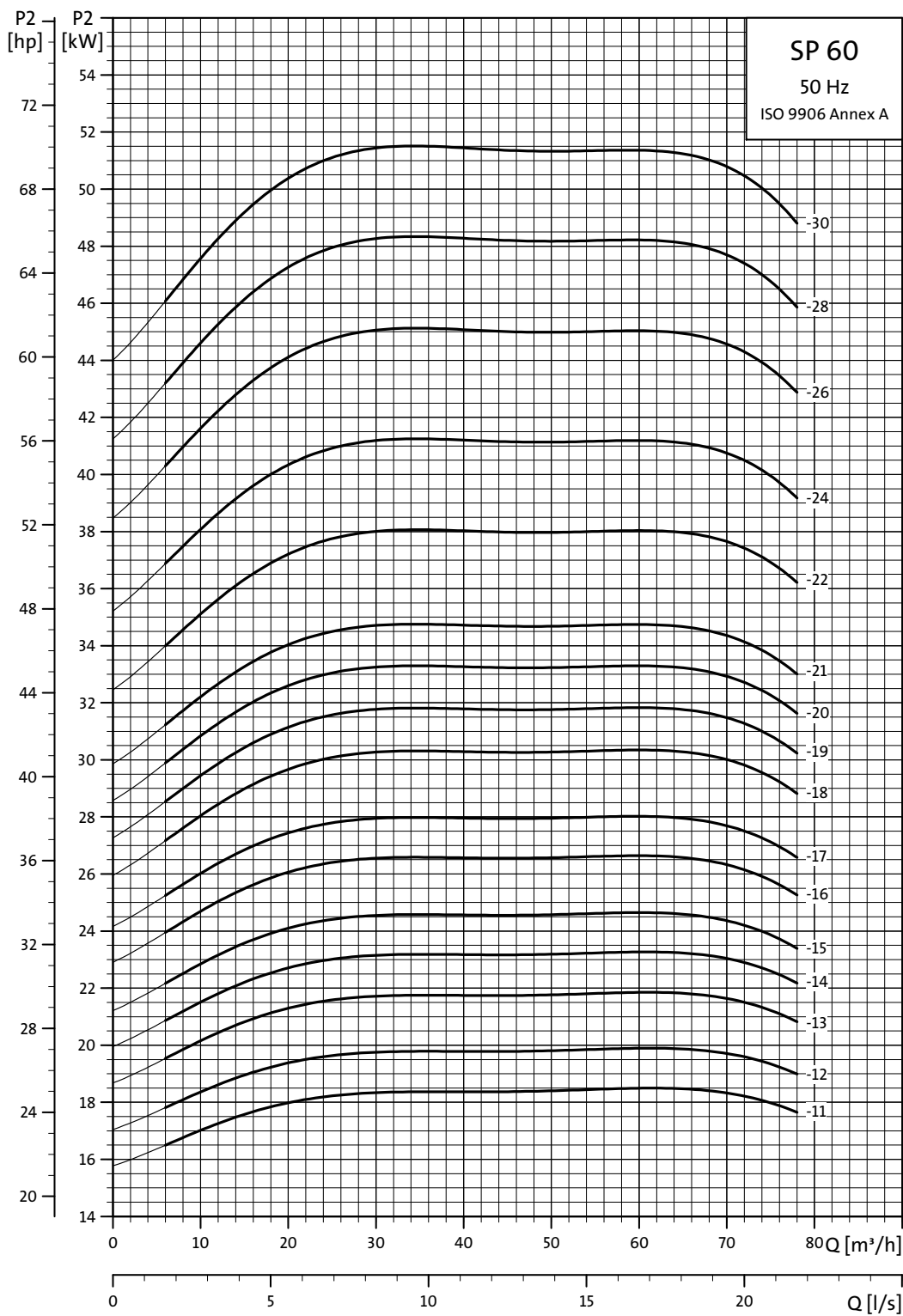

TM01 8829 4702

SP 77

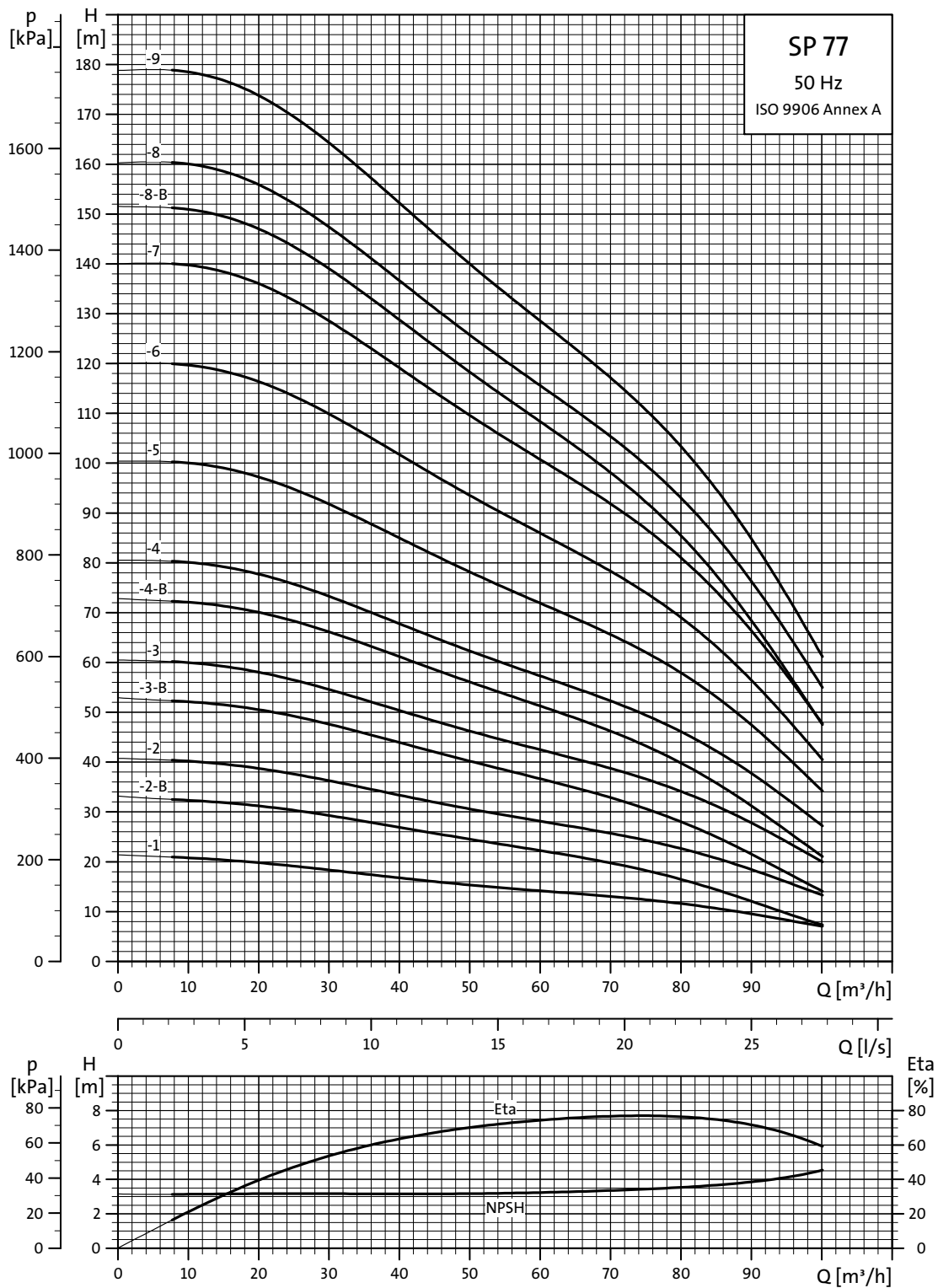

TM01 8769 4702

Explanation of efficiency curve, please see *Curve conditions*, page 4.

Performance curves

Submersible pumps
SP 77

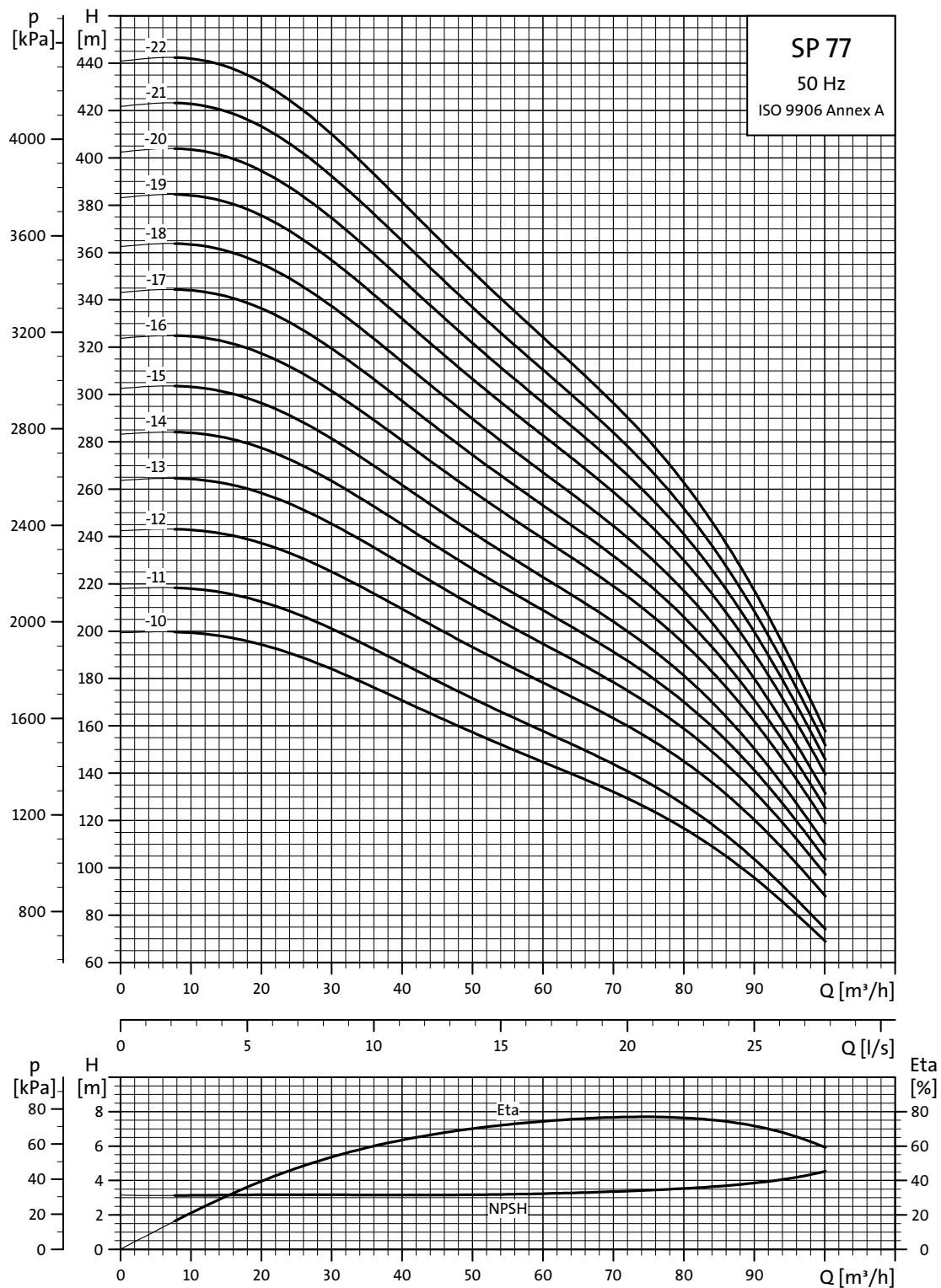

TM01 8770 4702

Explanation of efficiency curve, please see *Curve conditions*, page 4.

Dimensions and weights

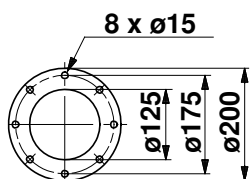
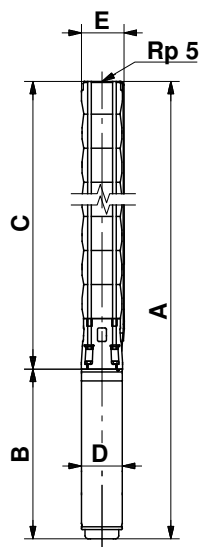

TM00 7872 2196

TM00 7323 1798

Pump type	Motor		Dimensions [mm]								Net weight [kg]		
	Type	Power [kW]	Rp 5 connection				5" Grundfos flange					B	D
			A	C	E*	E**	A	C	E*	E**			
SP 77-1	MS6	5.5	1153	618	178	186	1153	618	200	200	535	143	55
SP 77-2-B	MS6	5.5	1281	746	178	186	1281	746	200	200	535	143	59
SP 77-2	MS6	7.5	1311	746	178	186	1311	746	200	200	565	143	63
SP 77-3-B	MS6	9.2	1464	874	178	186	1464	874	200	200	590	143	72
SP 77-3	MS6	11	1557	874	178	186	1557	874	200	200	683	143	75
SP 77-4-B	MS6	13	1711	1003	178	186	1711	1003	200	200	708	143	82
SP 77-4	MS6	15	1741	1003	178	186	1741	1003	200	200	738	143	86
SP 77-5	MS6	18.5	1914	1131	178	186	1914	1131	200	200	783	143	95
SP 77-6	MS6	22	2097	1259	178	186	2097	1259	200	200	838	143	105
SP 77-7	MS6	26	2290	1387	178	186	2290	1387	200	200	903	143	114
SP 77-8-B	MS6	26	2418	1515	178	186	2418	1515	200	200	903	143	118
SP 77-8	MS6	30	2483	1515	178	186	2483	1515	200	200	968	143	126
SP 77-9	MS6	30	2611	1643	178	186	2611	1643	200	200	968	143	129
SP 77-10	MMS 6000	37	3196	1771	178	186	3196	1771	200	200	1425	144	181
SP 77-11	MMS 6000	37	3339	1898	178	186	3323	1898	200	200	1425	144	184
SP 77-10	MMS6	37	3083	1771	178	186	3083	1771	200	200	1312	143	176
SP 77-11	MMS6	37	3226	1898	178	186	3210	1898	200	200	1312	143	179
SP 77-12	MMS 8000	45	3313	2043	200	204	3313	2043	209	209	1270	192	240
SP 77-13	MMS 8000	55	3522	2172	200	204	3522	2172	209	209	1350	192	259
SP 77-14	MMS 8000	55	3650	2300	200	204	3650	2300	209	209	1350	192	263
SP 77-15	MMS 8000	55	3779	2429	200	204					1350	192	266
SP 77-16	MMS 8000	63	4047	2557	200	204					1490	192	296
SP 77-17	MMS 8000	63	4175	2685	200	204					1490	192	300
SP 77-18	MMS 8000	63	4304	2814	200	204					1490	192	304
SP 77-19	MMS 8000	75	4826	3236	200	204					1590	192	334
SP 77-20	MMS 8000	75	4954	3364	200	204					1590	192	338
SP 77-21	MMS 8000	75	5082	3492	200	202					1590	192	342
SP 77-22	MMS 8000	92	5450	3620	200	202					1830	192	391

* Maximum diameter of pump with one motor cable.

** Maximum diameter of pump with two motor cables.

The pump types are also available in N- and R-versions. See page 5. Dimensions as above.

Other types of connection are possible by means of connecting pieces. See page 87.

Power curves

Submersible pumps
SP 77

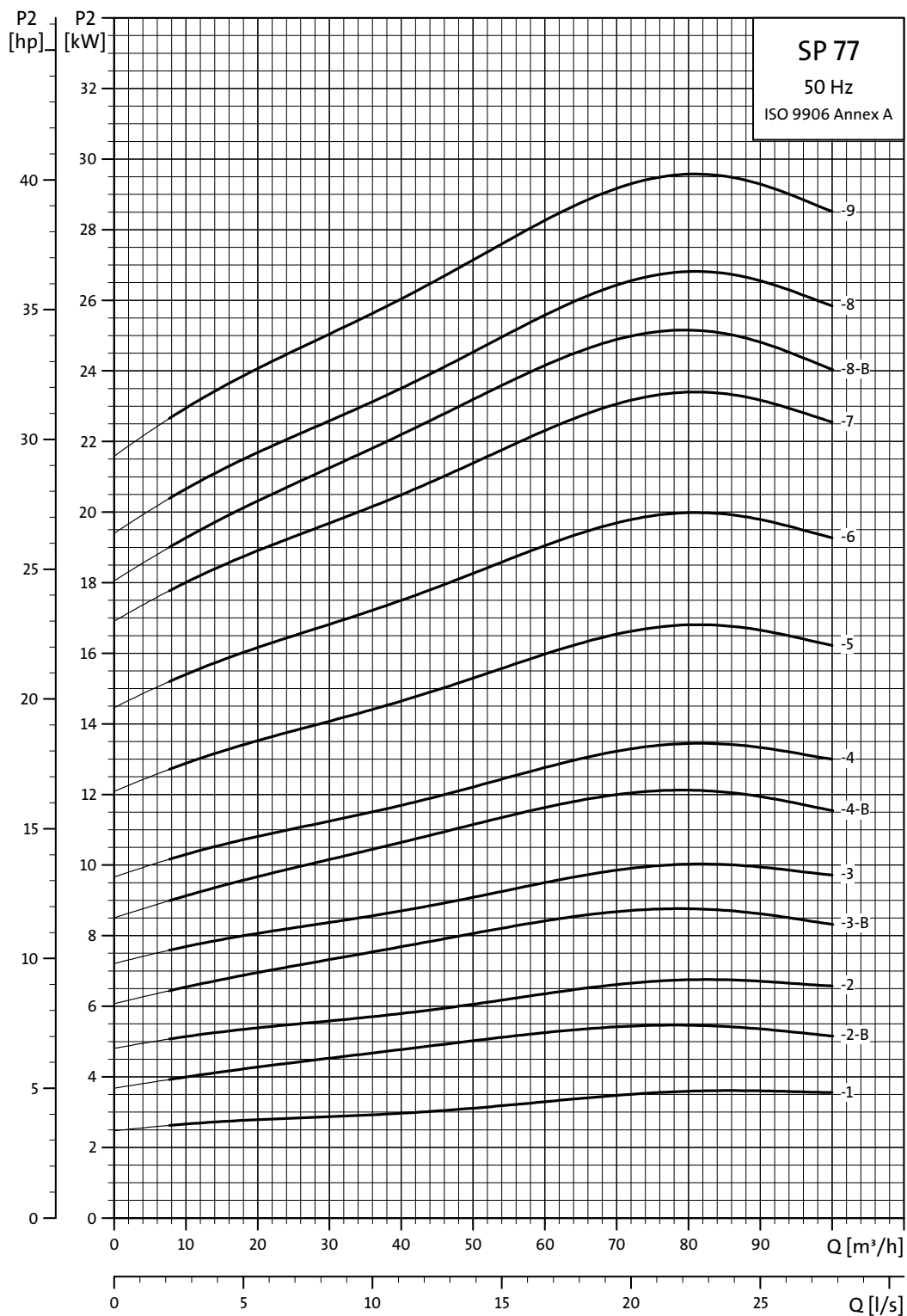

TM01 8771 4702

Power curves

Submersible pumps
SP 77

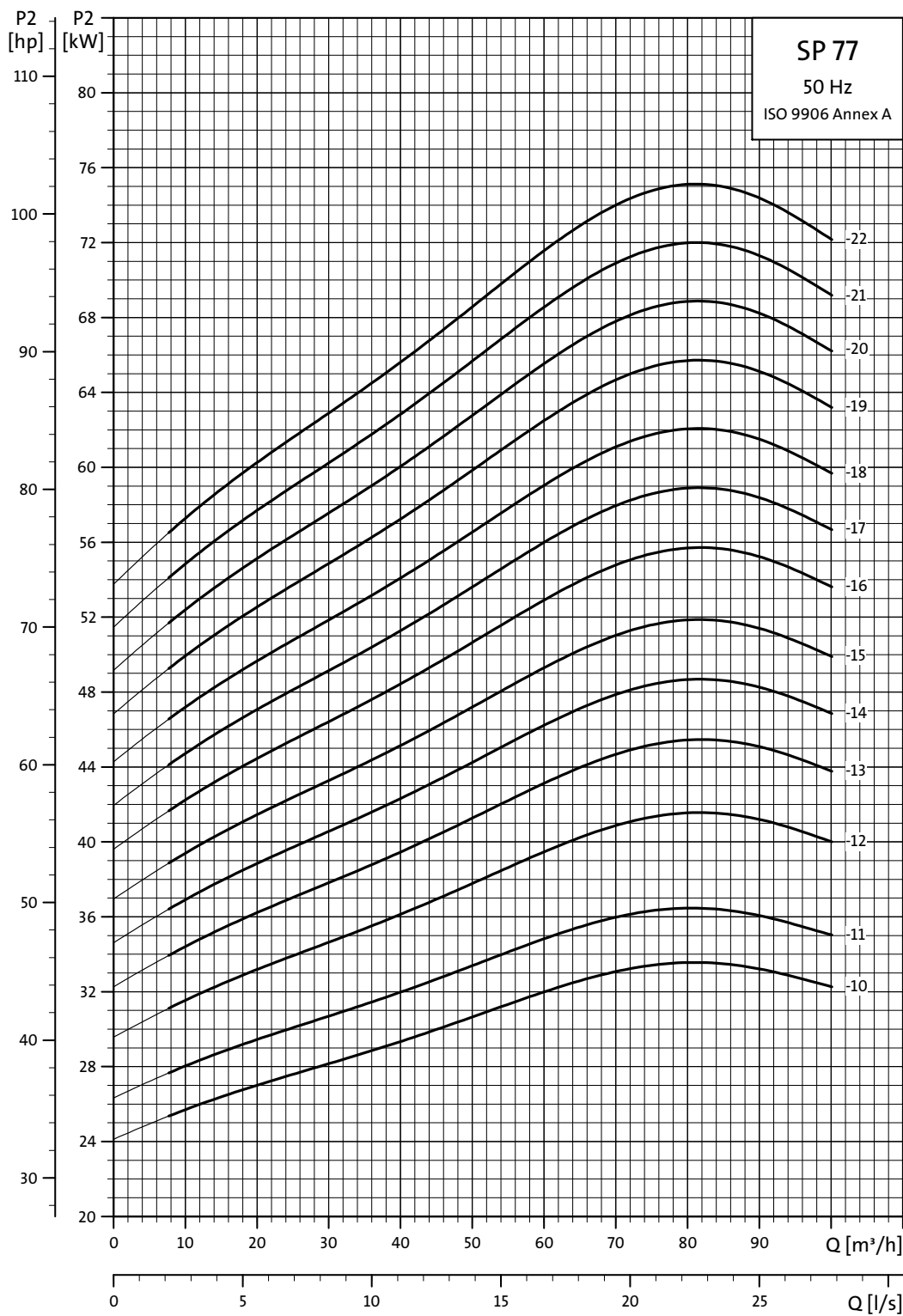

TM01 8772 4702

SP 95

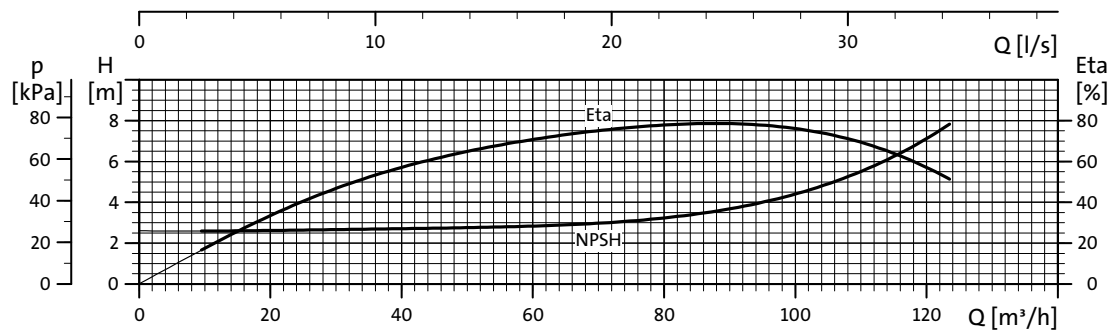
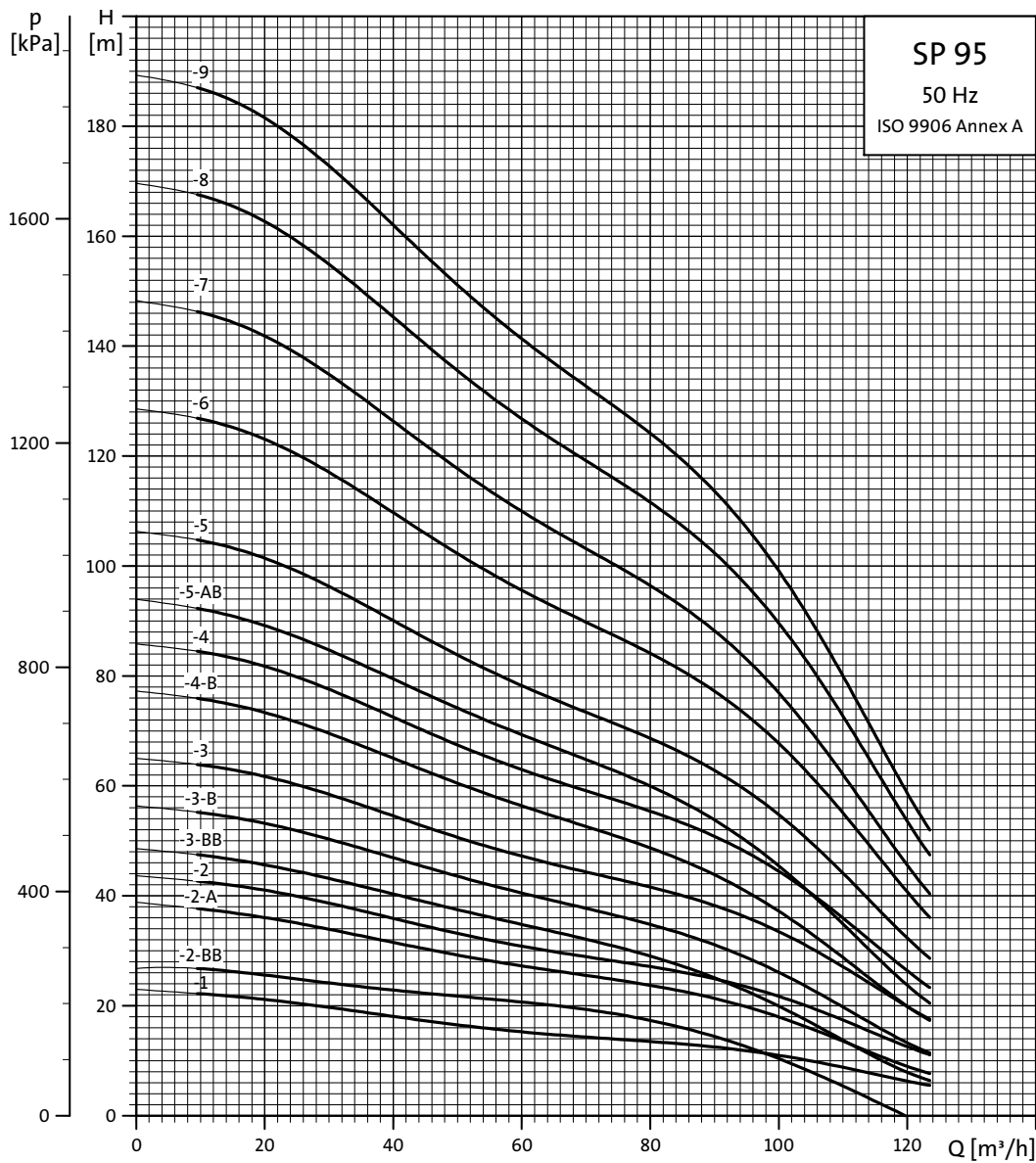

TM01 8773 4702

Explanation of efficiency curve, please see *Curve conditions*, page 4.

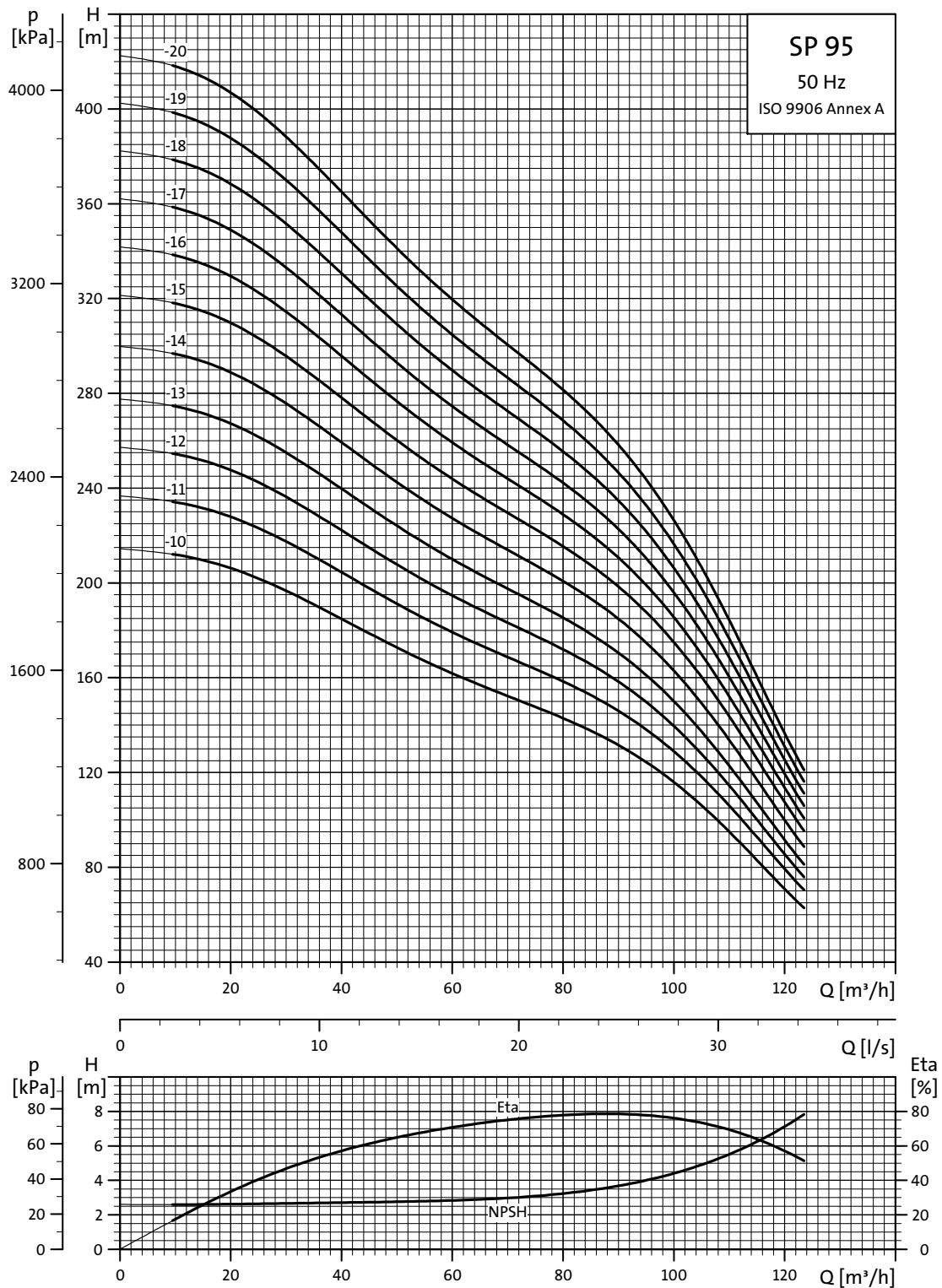

TM01 8774 4702

Explanation of efficiency curve, please see *Curve conditions*, page 4.

Dimensions and weights

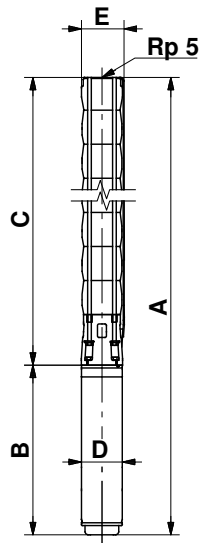

TM00 7872 2196

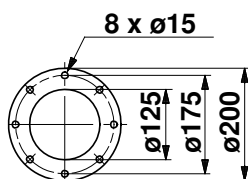

TM00 7323 1798

Pump type	Motor		Dimensions [mm]								Net weight [kg]		
	Type	Power [kW]	Rp 5 connection				5" Grundfos flange					B	D
			A	C	E*	E**	A	C	E*	E**			
SP 95-1	MS6	5.5	1153	618	178	186	1153	618	200	200	535	143	55
SP 95-2-BB	MS6	5.5	1281	746	178	186	1281	746	200	200	535	143	72
SP 95-2-A	MS6	7.5	1311	746	178	186	1311	746	200	200	565	143	63
SP 95-2	MS6	9.2	1336	746	178	186	1336	746	200	200	590	143	68
SP 95-3-BB	MS6	9.2	1464	874	178	186	1464	874	200	200	590	143	72
SP 95-3-B	MS6	11	1557	874	178	186	1557	874	200	200	683	143	75
SP 95-3	MS6	13	1582	874	178	186	1582	874	200	200	708	143	78
SP 95-4-B	MS6	15	1741	1003	178	186	1741	1003	200	200	738	143	86
SP 95-4	MS6	18.5	1786	1003	178	186	1786	1003	200	200	783	143	91
SP 95-5-AB	MS6	18.5	1914	1131	178	186	1914	1131	200	200	783	143	95
SP 95-5	MS6	22	1969	1131	178	186	1969	1131	200	200	838	143	101
SP 95-6	MS6	26	2162	1259	178	186	2162	1259	200	200	903	143	110
SP 95-7	MS6	30	2355	1387	178	186	2355	1387	200	200	968	143	122
SP 95-8	MMS 6000	37	2940	1515	178	186	2940	1515	200	200	1425	144	173
SP 95-9	MMS 6000	37	3067	1642	178	186	3076	1642	200	200	1425	144	177
SP 95-8	MMS6	37	2827	1515	178	186	2827	1515	200	200	1312	143	168
SP 95-9	MMS6	37	2954	1642	178	186	2954	1642	200	200	1312	143	172
SP 95-10	MMS 8000	45	3055	1785	196	204	3055	1785	205	205	1270	192	233
SP 95-11	MMS 8000	55	3264	1914	196	204	3264	1914	205	205	1350	192	251
SP 95-12	MMS 8000	55	3393	2043	196	204	3393	2043	205	205	1350	192	255
SP 95-13	MMS 8000	55	3522	2172	196	204	3522	2172	205	205	1350	192	259
SP 95-14	MMS 8000	63	3790	2300	196	204	3790	2300	205	205	1490	192	289
SP 95-15	MMS 8000	75	4019	2429	196	204					1590	192	311
SP 95-16	MMS 8000	75	4147	2557	196	204					1590	192	315
SP 95-17	MMS 8000	75	4275	2685	196	204					1590	192	319
SP 95-18	MMS 8000	92	4938	3108	196	204					1830	192	376
SP 95-19	MMS 8000	92	5066	3236	196	204					1830	192	380
SP 95-20	MMS 8000	92	5194	3364	196	204					1830	192	384

* Maximum diameter of pump with one motor cable.

** Maximum diameter of pump with two motor cables.

The pump types above are also available in N- and R-versions. See page 5. Dimensions as above.

Other types of connection are possible by means of connecting pieces. See page 87.

Power curves

Submersible pumps
SP 95

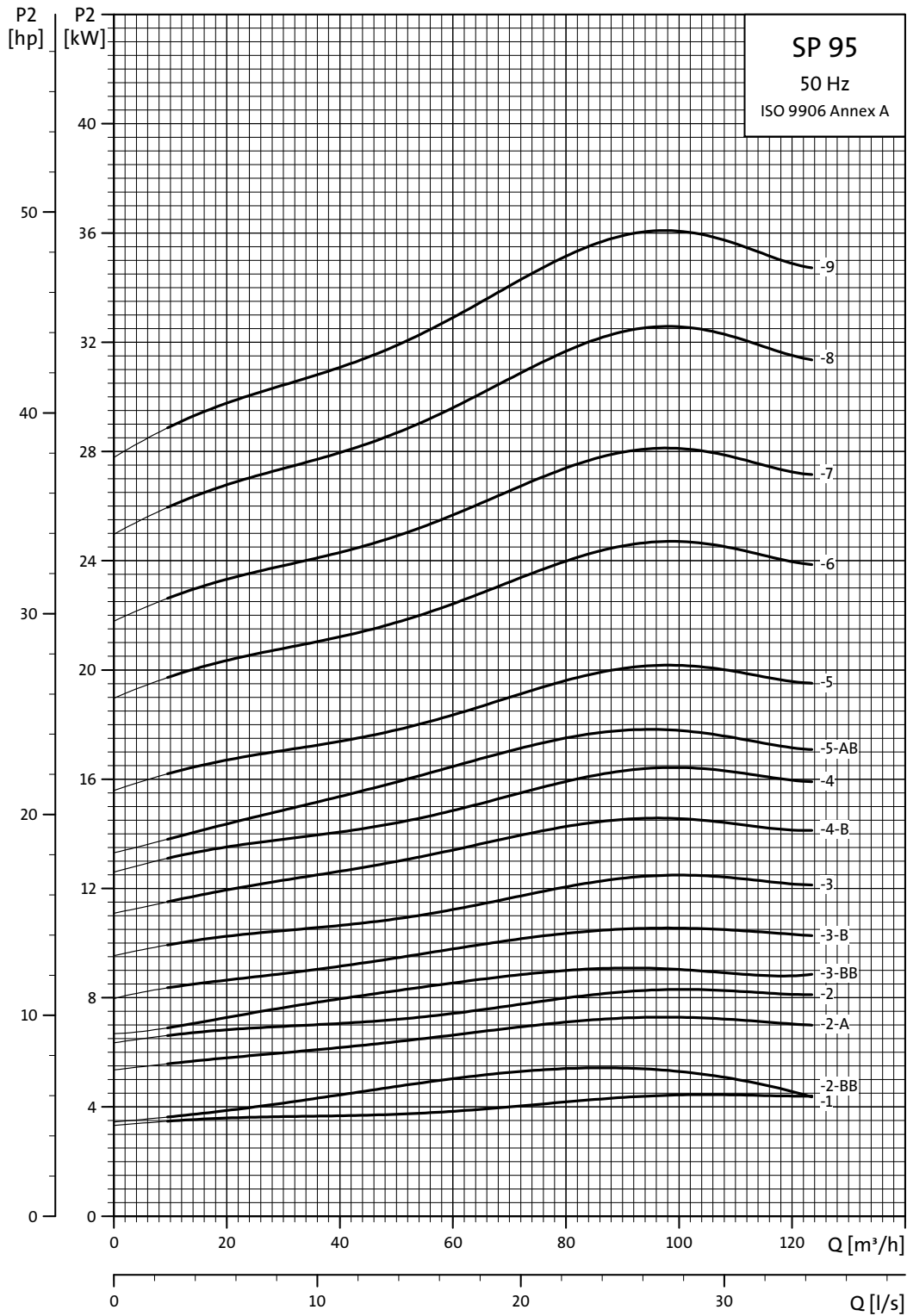

TIM01 8775 4702

Power curves

Submersible pumps
SP 95

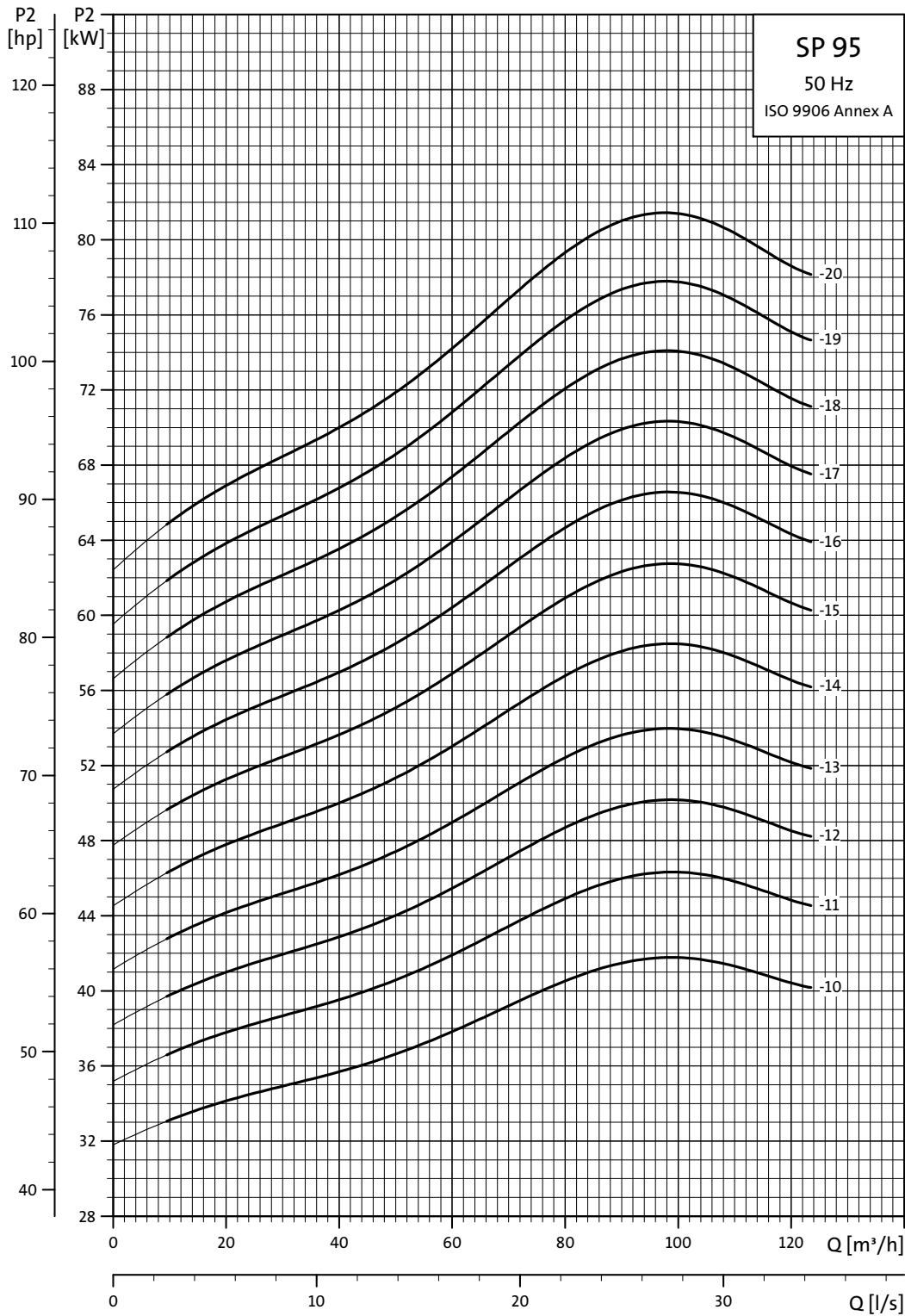

TM01 8776 4702

Performance curves

Submersible pumps
SP 125

SP 125

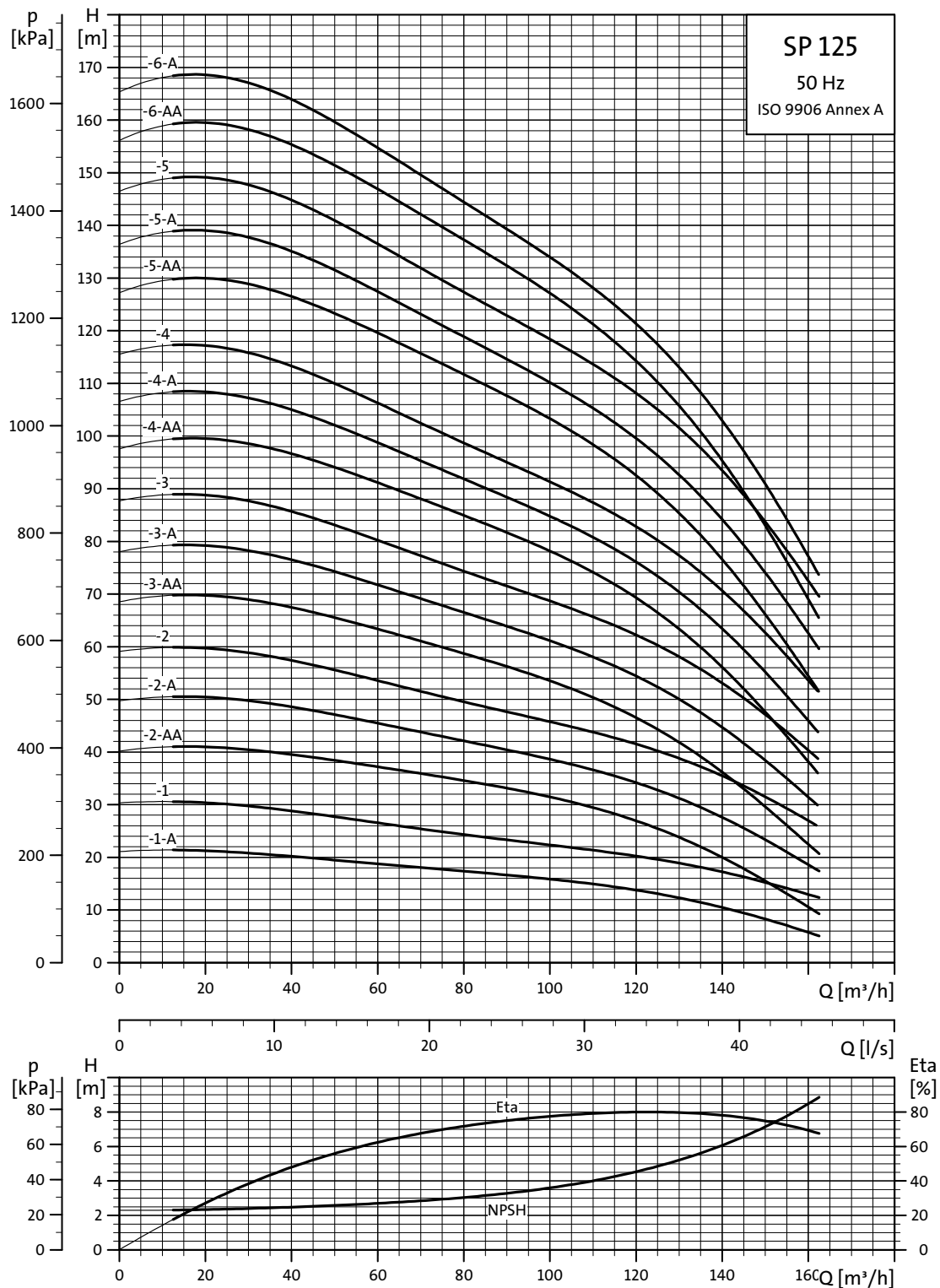

Explanation of efficiency curve, please see *Curve conditions*, page 4.

TM01 8777 4702

Performance curves

Submersible pumps
SP 125

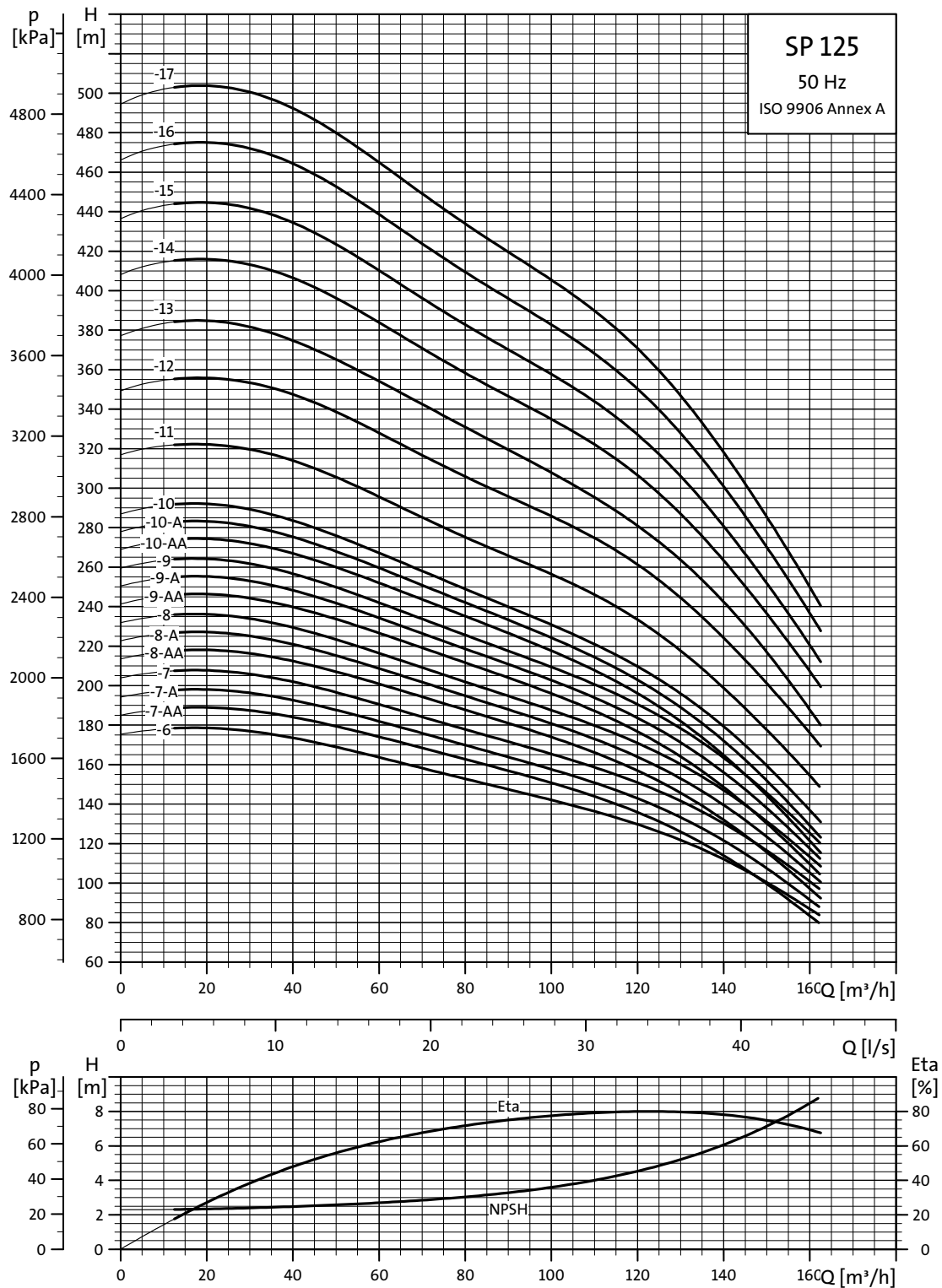

TM01 8778 4702

Explanation of efficiency curve, please see *Curve conditions*, page 4.

Dimensions and weights

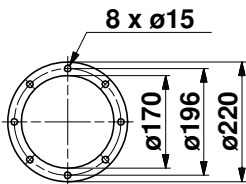
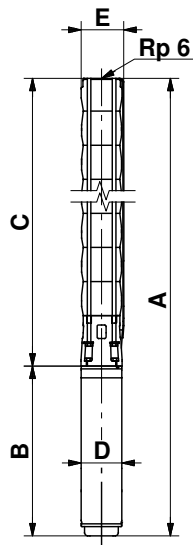

TM00 8760 3596

TM00 7324 1798

Pump type	Motor		Dimensions [mm]								Net weight [kg]		
	Type	Power [kW]	Rp 6 connection				6" Grundfos flange					B	D
			A	C	E*	E**	A	C	E*	E**			
SP 125-1-A	MS6	7.5	1216	651	211	218	1216	651	222	226	565	143	70
SP 125-1	MS6	11	1334	651	211	218	1334	651	222	226	683	143	79
SP 125-2-AA	MS6	13	1515	807	211	218	1515	807	222	226	708	143	88
SP 125-2-A	MS6	18.5	1590	807	211	218	1590	807	222	226	783	143	97
SP 125-2	MS6	22	1645	807	211	218	1645	807	222	226	838	143	103
SP 125-3-AA	MS6	22	1801	963	211	218	1801	963	222	226	838	143	109
SP 125-3-A	MS6	26	1866	963	211	218	1866	963	222	226	903	143	115
SP 125-3	MS6	30	1931	963	211	218	1931	963	222	226	968	143	123
SP 125-4-AA	MMS 6000	37	2544	1119	211	218	2544	1119	222	226	1425	144	176
SP 125-4-A	MMS 6000	37	2544	1119	211	218	2544	1119	222	226	1425	144	176
SP 125-4	MMS 6000	37	2544	1119	211	218	2544	1119	222	226	1425	144	176
SP 125-4-AA	MMS6	37	2431	1119	211	218	2431	1119	222	226	1312	143	171
SP 125-4-A	MMS6	37	2431	1119	211	218	2431	1119	222	226	1312	143	171
SP 125-4	MMS6	37	2431	1119	211	218	2431	1119	222	226	1312	143	171
SP 125-5-AA	MMS 8000	45	2545	1275	213	218	2545	1275	223	226	1270	192	236
SP 125-5-A	MMS 8000	45	2545	1275	213	218	2545	1275	223	226	1270	192	236
SP 125-5	MMS 8000	55	2625	1275	213	218	2625	1245	223	226	1350	192	251
SP 125-6-AA	MMS 8000	55	2781	1431	213	218	2781	1431	223	226	1350	192	257
SP 125-6-A	MMS 8000	55	2781	1431	213	218	2781	1431	223	226	1350	192	257
SP 125-6	MMS 8000	63	2921	1431	218	227	2921	1431	229	232	1490	192	283
SP 125-7-AA	MMS 8000	63	3077	1587	218	227	3077	1587	229	232	1490	192	289
SP 125-7-A	MMS 8000	63	3077	1587	218	227	3077	1587	229	232	1490	192	289
SP 125-7	MMS 8000	75	3177	1587	218	227	3177	1587	229	232	1590	192	308
SP 125-8-AA	MMS 8000	75	3333	1743	218	227					1590	192	314
SP 125-8-A	MMS 8000	75	3333	1743	218	227					1590	192	314
SP 125-8	MMS 8000	75	3333	1743	218	227					1590	192	314
SP 125-9-AA	MMS 8000	92	3729	1899	218	227					1830	192	366
SP 125-9-A	MMS 8000	92	3729	1899	218	227					1830	192	366
SP 125-9	MMS 8000	92	3729	1899	218	227					1830	192	366
SP 125-10-AA	MMS 8000	92	3885	2055	218	227					1830	192	372
SP 125-10-A	MMS 8000	92	3885	2055	218	227					1830	192	372
SP 125-10	MMS 8000	92	3885	2055	218	227					1830	192	372
SP 125-11	MMS 8000	110	4567	2507	218	227					2060	192	438
SP 125-12	MMS 10000	132	4584	2714	237	237					1870	237	556
SP 125-13	MMS 10000	132	4740	2870	237	237					1870	237	562
SP 125-14	MMS 10000	147	5095	3025	237	237					2070	237	633
SP 125-15	MMS 10000	147	5251	3181	237	237					2070	237	639
SP 125-16	MMS 10000	170	5556	3336	237	237					2220	237	685
SP 125-17	MMS 10000	170	5712	3492	237	237					2220	237	691

* Maximum diameter of pump with one motor cable.

** Maximum diameter of pump with two motor cables.

The pump types above are also available in N- and R-versions. See page 5. Dimensions as above.

Other types of connection are possible by means of connecting pieces. See page 87.

Power curves

Submersible pumps
SP 125

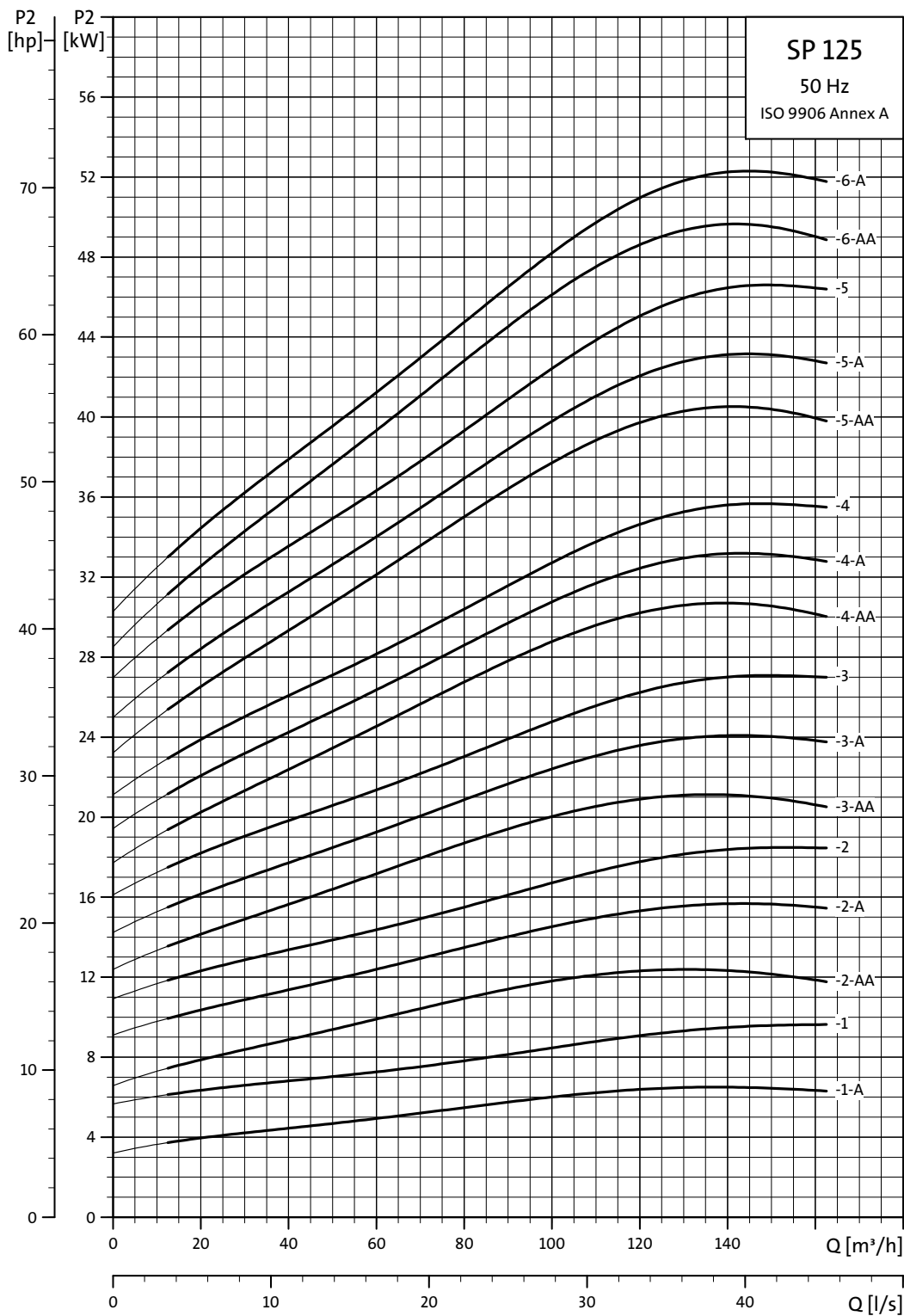

TM01 8779 4702

Power curves

Submersible pumps
SP 125

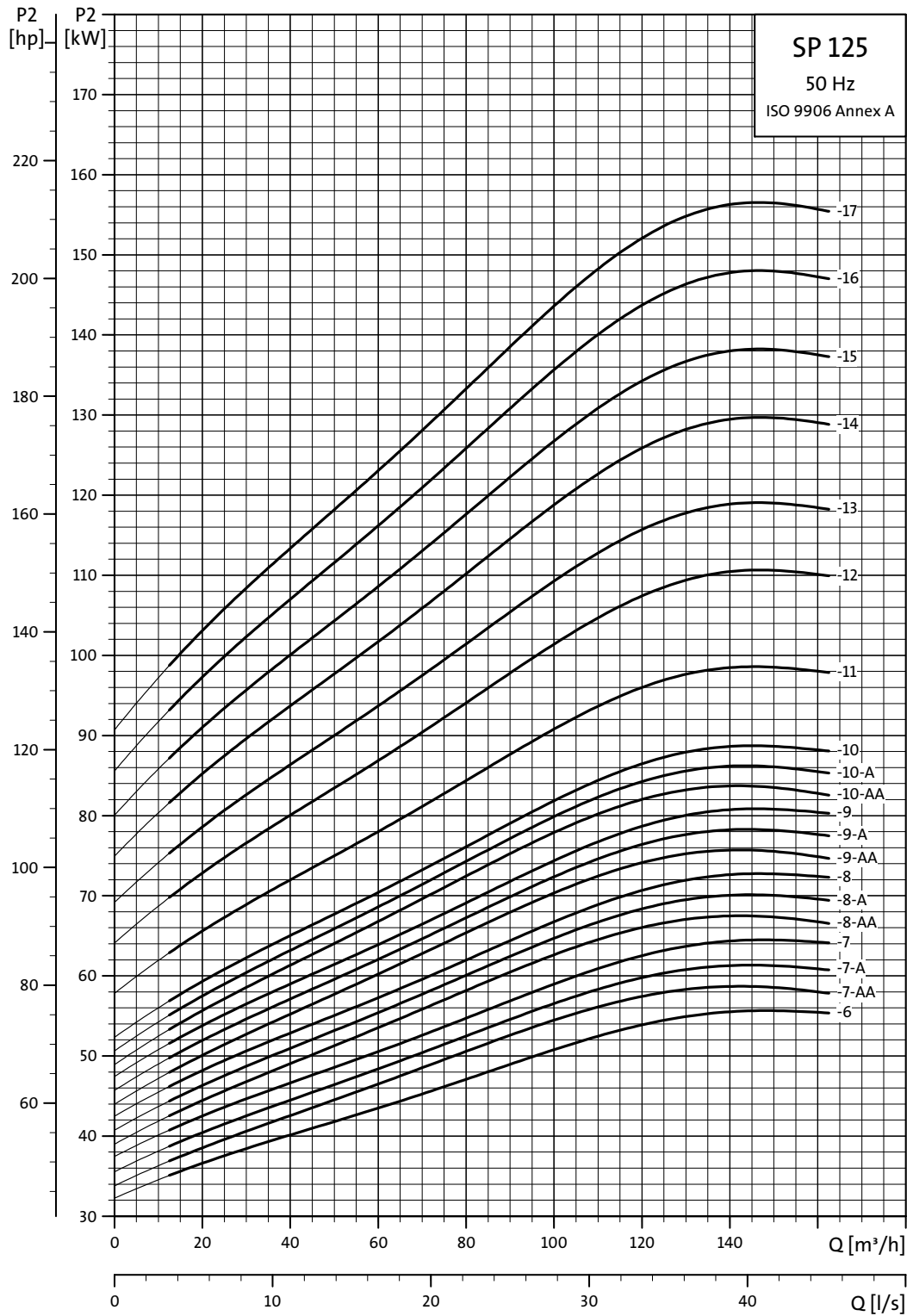

TM01 8780 4702

Performance curves

Submersible pumps
SP 160

SP 160

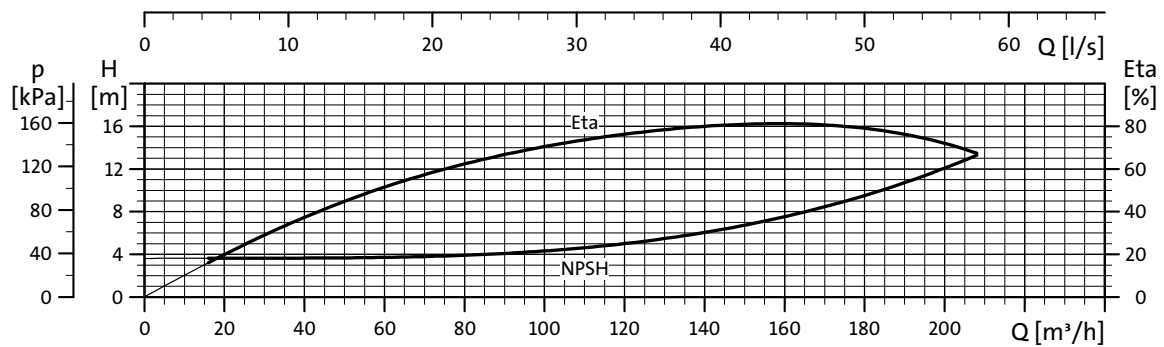
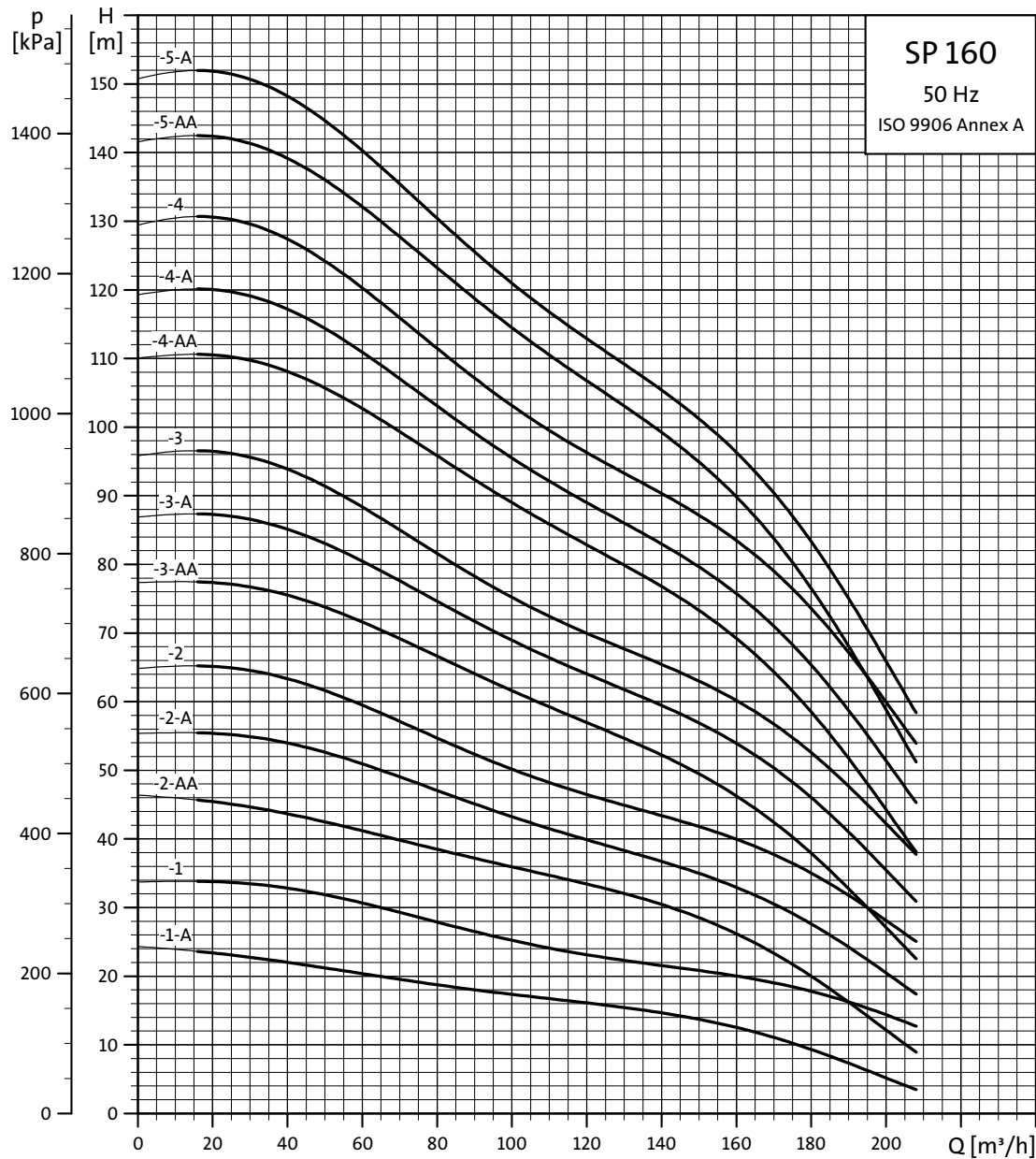

Explanation of efficiency curve, please see *Curve conditions*, page 4.

TM01 8781 4702

Performance curves

Submersible pumps
SP 160

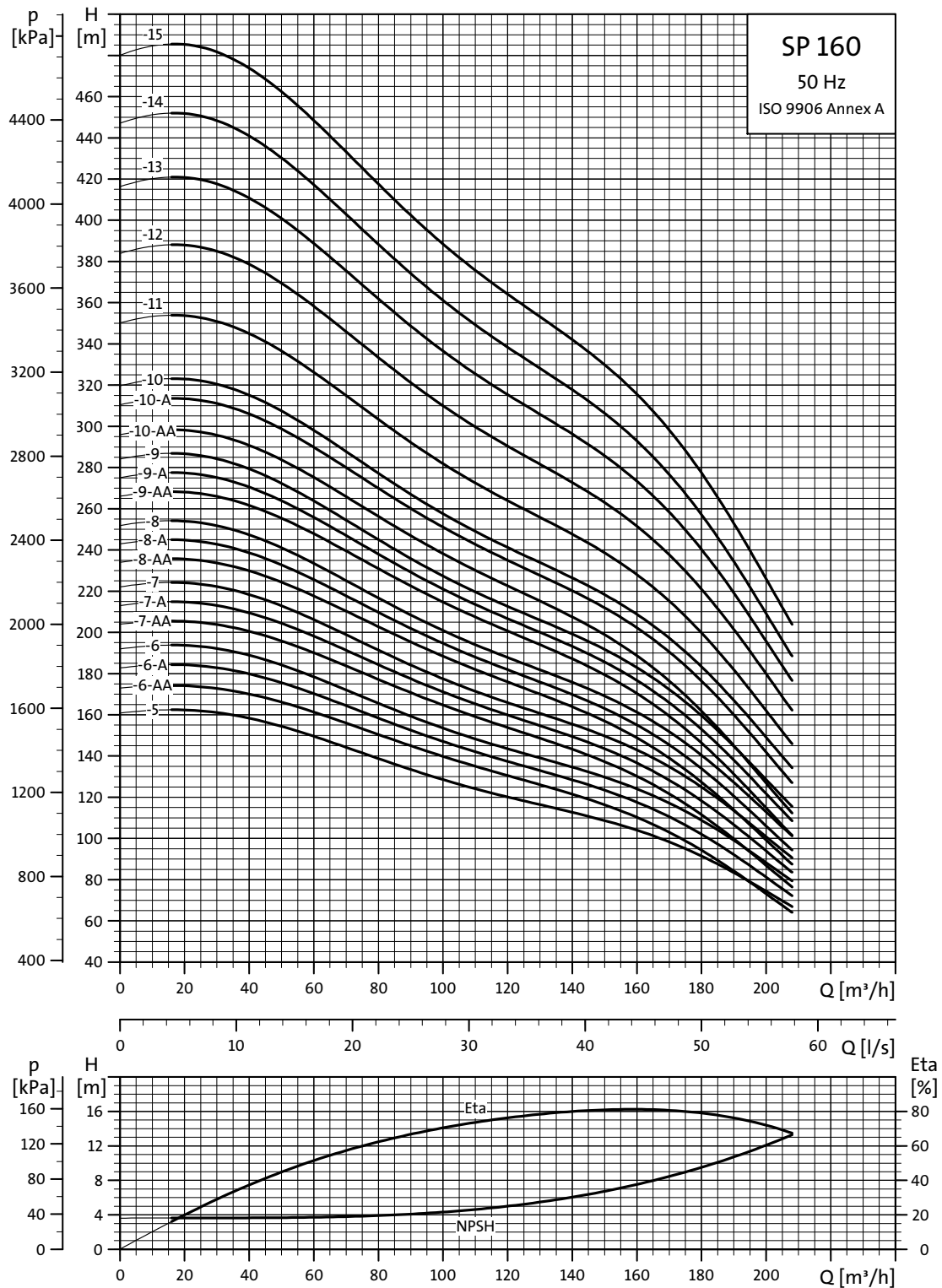

TM00 8782 4702

Explanation of efficiency curve, please see *Curve conditions*, page 4.

Dimensions and weights

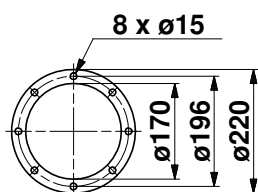
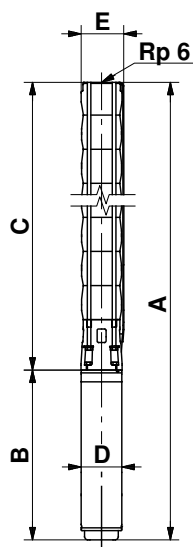

TM00 8760 3596

TM00 7324 1798

Pump type	Motor		Dimensions [mm]								Net weight [kg]		
	Type	Power [kW]	Rp 6 connection				6" Grundfos flange						
			A	C	E*	E**	A	C	E*	E**			
SP 160-1-A	MS6	9.2	1241	651	211	218	1241	651	222	226	590	143	76
SP 160-1	MS6	13	1359	651	211	218	1359	651	222	226	708	143	82
SP 160-2-AA	MS6	18.5	1590	807	211	218	1590	807	222	226	783	143	97
SP 160-2-A	MS6	22	1645	807	211	218	1645	807	222	226	838	143	103
SP 160-2	MS6	26	1710	807	211	218	1710	807	222	226	903	143	109
SP 160-3-AA	MS6	30	1931	963	211	218	1931	963	222	226	968	143	123
SP 160-3-A	MMS 6000	37	2388	963	211	218	2388	963	222	226	1425	144	170
SP 160-3	MMS 6000	37	2388	963	211	218	2388	963	222	226	1425	144	170
SP 160-3-A	MMS6	37	2275	963	211	218	2275	963	222	226	1312	143	165
SP 160-3	MMS6	37	2275	963	211	218	2275	963	222	226	1312	143	165
SP 160-4-AA	MMS 8000	45	2389	1119	218	227	2389	1119	229	232	1270	192	230
SP 160-4-A	MMS 8000	45	2389	1119	218	227	2389	1119	229	232	1270	192	230
SP 160-4	MMS 8000	55	2469	1119	218	227	2469	1119	229	232	1350	192	245
SP 160-5-AA	MMS 8000	55	2625	1275	218	227	2625	1275	229	232	1350	192	251
SP 160-5-A	MMS 8000	55	2625	1275	218	227	2625	1275	229	232	1350	192	251
SP 160-5	MMS 8000	63	2765	1275	218	227	2765	1275	229	232	1490	192	277
SP 160-6-AA	MMS 8000	63	2921	1431	218	227	2921	1431	229	232	1490	192	283
SP 160-6-A	MMS 8000	75	3021	1431	218	227	3021	1431	229	232	1590	192	302
SP 160-6	MMS 8000	75	3021	1431	218	227	3021	1431	229	232	1590	192	302
SP 160-7-AA	MMS 8000	75	3177	1587	218	227					1590	192	302
SP 160-7-A	MMS 8000	92	3417	1587	218	227					1830	192	354
SP 160-7	MMS 8000	92	3417	1587	218	227					1830	192	354
SP 160-8-AA	MMS 8000	92	3573	1743	218	227					1830	192	360
SP 160-8-A	MMS 8000	92	3573	1743	218	227					1830	192	360
SP 160-8	MMS 8000	92	3573	1743	218	227					1830	192	360
SP 160-9-AA	MMS 8000	110	3959	1899	218	227					2060	192	416
SP 160-9-A	MMS 8000	110	3959	1899	218	227					2060	192	416
SP 160-9	MMS 8000	110	3959	1899	218	227					2060	192	416
SP 160-10-AA	MMS 8000	110	4411	2351	218	227					2060	192	432
SP 160-10-A	MMS 10000	132	4273	2403	237	237					1870	237	544
SP 160-10	MMS 10000	132	4273	2403	237	237					1870	237	544
SP 160-11	MMS 10000	132	4429	2559	237	237					1870	237	550
SP 160-12	MMS 10000	147	4784	2714	237	237					2070	237	621
SP 160-13	MMS 10000	170	5090	2870	237	237					2220	237	667
SP 160-14	MMS 10000	170	5245	3025	237	237					2220	237	673
SP 160-15	MMS 12000	190	5239	3259	286	286					1980	286	803

* Maximum diameter of pump with one motor cable.

** Maximum diameter of pump with two motor cables.

The pump types above are also available in N-versions. See page 5. Dimensions as above.

SP 160-1-A to SP 160-14 are also available in R-versions. See page 5. Dimensions as above.

Other types of connection are possible by means of connecting pieces. See page 87.

Power curves

Submersible pumps
SP 160

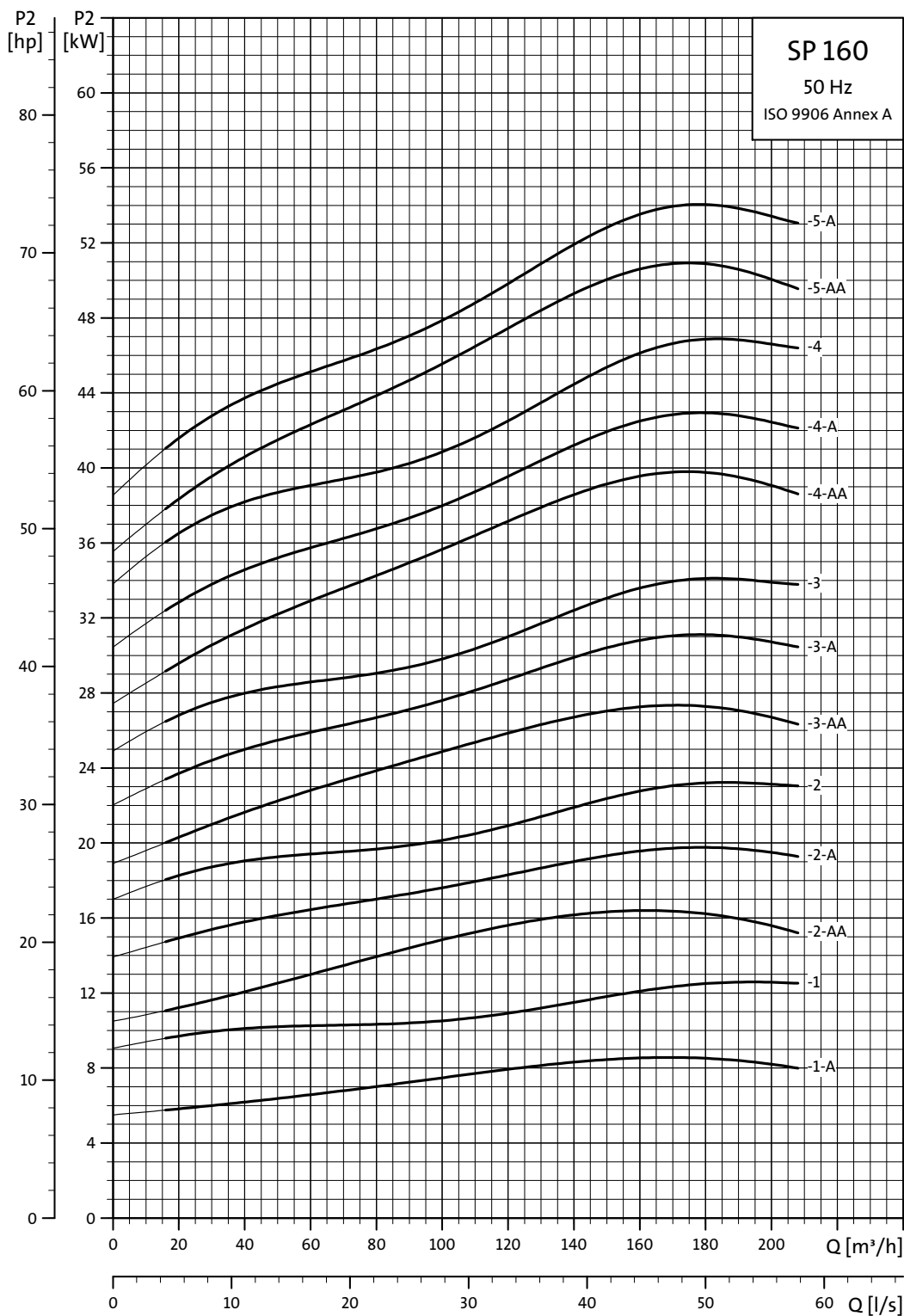

TM00 8783 4702

Power curves

Submersible pumps
SP 160

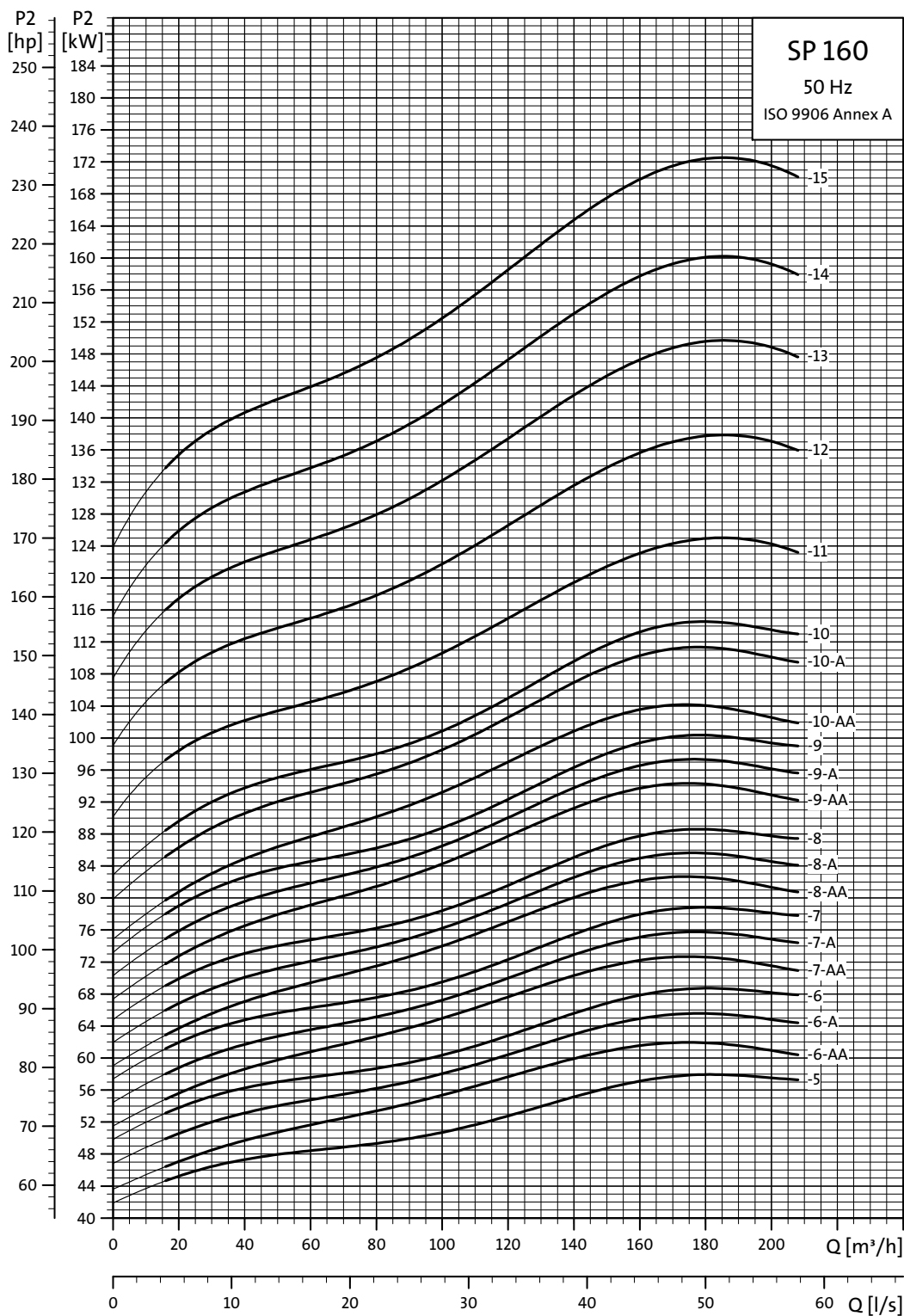

TM00 8784 4702

Performance curves

Submersible pumps
SP 215

SP 215

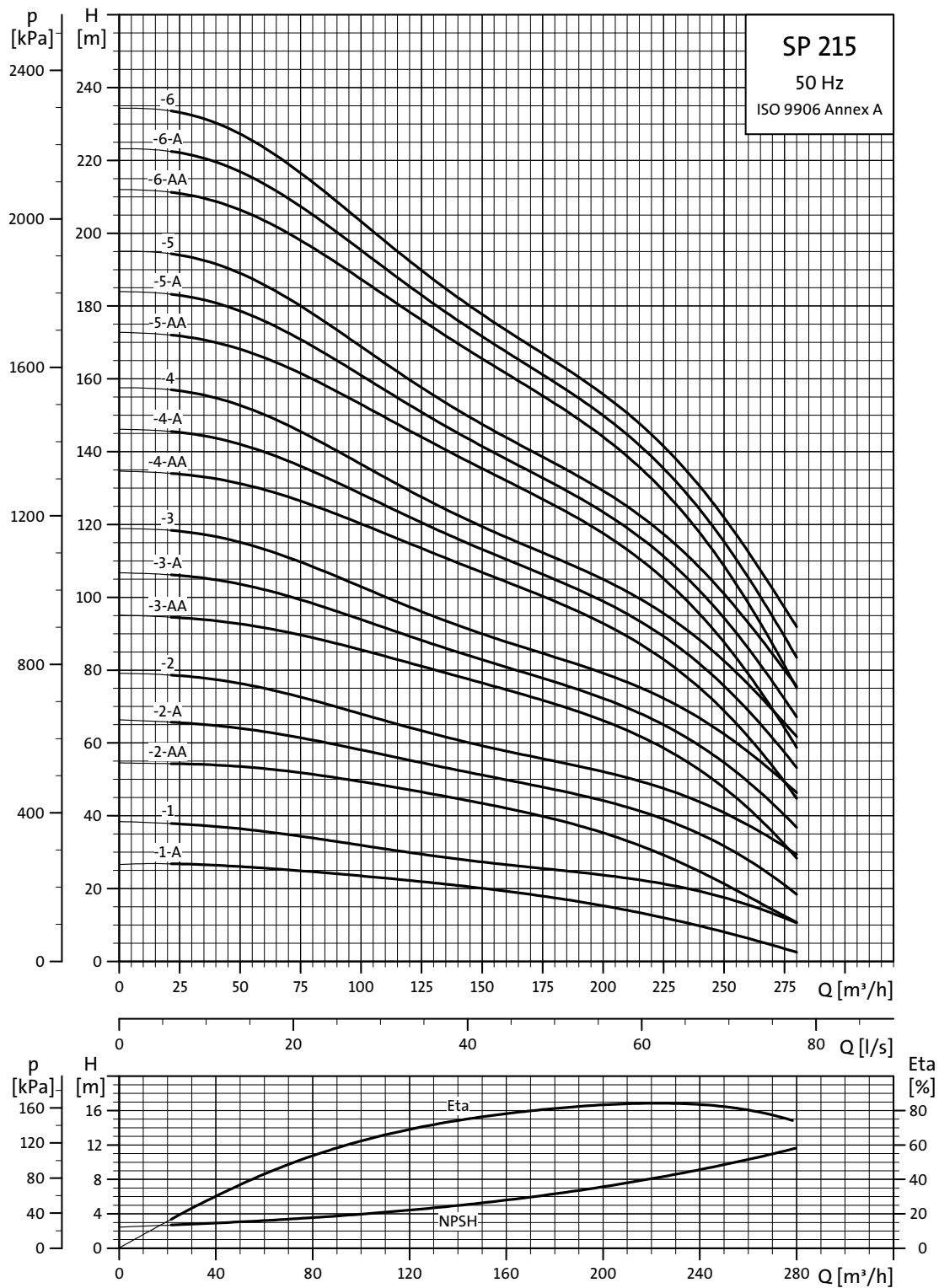

Explanation of efficiency curve, please see *Curve conditions*, page 4.

TM00 8785 4702

Performance curves

Submersible pumps
SP 215

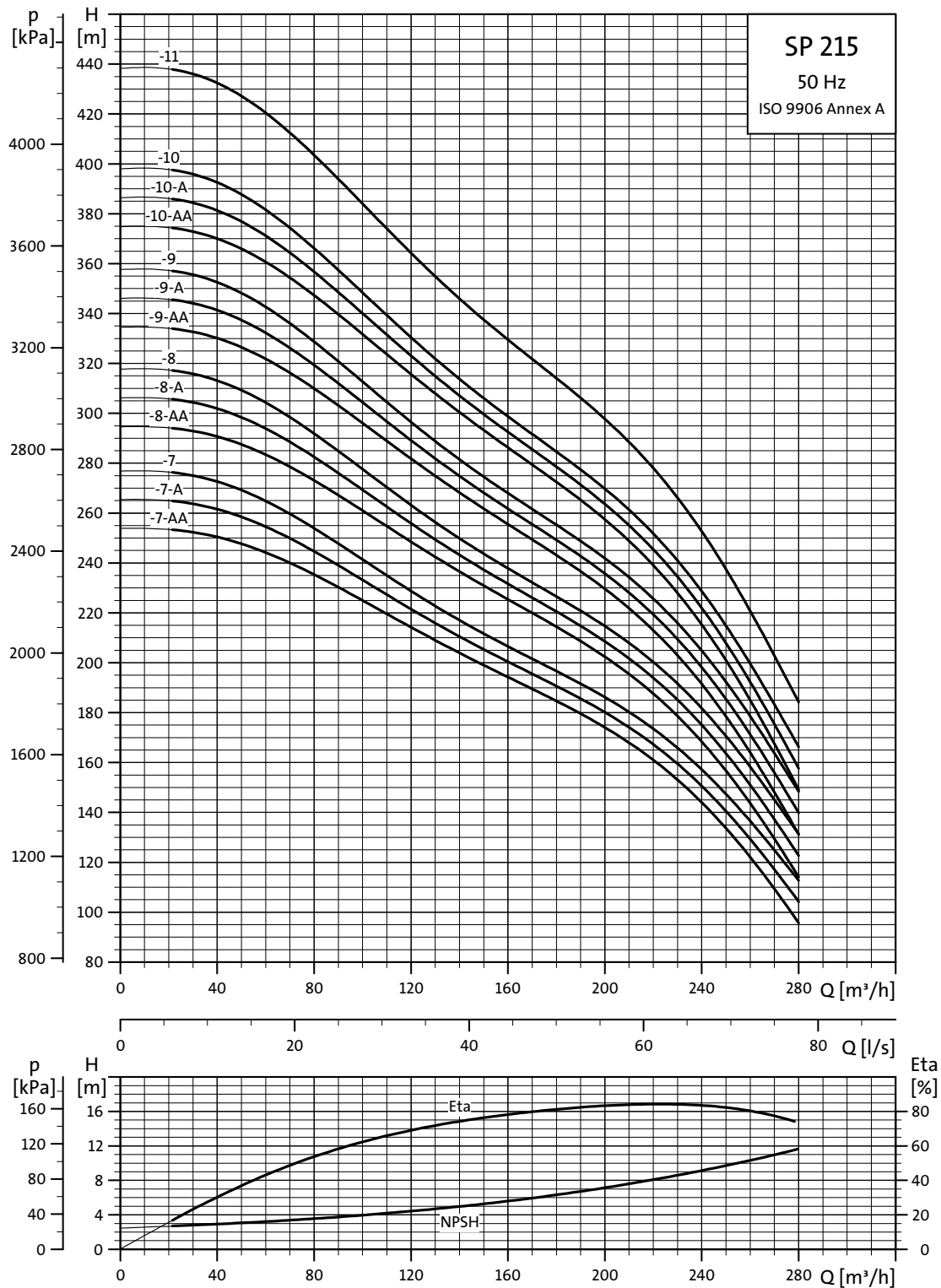

TM01 8786 4702

Explanation of efficiency curve, please see *Curve conditions*, page 4.

Dimensions and weights

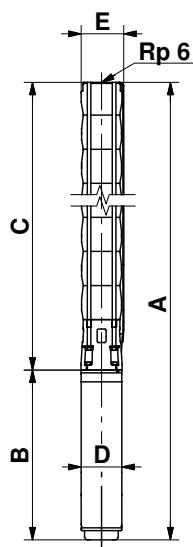

TM00 8760 3596

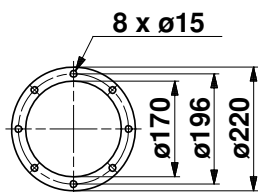

TM00 7324 1798

Pump type	Motor		Dimensions [mm]								Net weight [kg]		
	Type	Power [kW]	Rp 6 connection				6" Grundfos flange					B	D
			A	C	E*	E**	A	C	E*	E**			
SP 215-1-A	MS6	15	1528	790	241	247	1528	790	241	247	738	143	92
SP 215-1	MS6	18.5	1573	790	241	247	1573	790	241	247	783	143	97
SP 215-2-AA	MS6	30	1934	966	241	247	1934	966	241	247	968	143	127
SP 215-2-A	MMS 6000	37	2391	966	241	247	2391	966	241	247	1425	144	174
SP 215-2-A	MMS6	37	2278	966	241	247	2278	966	241	247	1312	143	169
SP 215-2	MMS 8000	45	2236	966	241	247	2236	966	241	247	1270	192	228
SP 215-3-AA	MMS 8000	55	2492	1142	241	247	2492	1142	241	247	1350	192	253
SP 215-3-A	MMS 8000	55	2492	1142	241	247	2492	1142	241	247	1350	192	253
SP 215-3	MMS 8000	63	2632	1142	241	247	2632	1142	241	247	1490	192	279
SP 215-4-AA	MMS 8000	75	2908	1318	241	247	2908	1318	241	247	1590	192	308
SP 215-4-A	MMS 8000	75	2908	1318	241	247	2908	1318	241	247	1590	192	308
SP 215-4	MMS 8000	75	2908	1318	241	247	2908	1318	241	247	1590	192	308
SP 215-5-AA	MMS 8000	92	3324	1494	241	247	3324	1494	241	247	1830	192	364
SP 215-5-A	MMS 8000	92	3324	1494	241	247	3324	1494	241	247	1830	192	364
SP 215-5	MMS 8000	92	3554	1494	241	247	3554	1494	241	247	1830	192	364
SP 215-6-AA	MMS 8000	110	3730	1670	241	247	3730	1670	241	247	2060	192	424
SP 215-6-A	MMS 8000	110	3730	1670	241	247	3730	1670	241	247	2060	192	424
SP 215-6	MMS 8000	110	3730	1670	241	247	3730	1670	241	247	2060	192	424
SP 215-7-AA	MMS 10000	132	4016	2146	241	247					1870	237	547
SP 215-7-A	MMS 10000	132	4016	2146	241	247					1870	237	547
SP 215-7	MMS 10000	132	4016	2146	241	247					1870	237	547
SP 215-8-AA	MMS 10000	147	4392	2322	241	247					2070	237	622
SP 215-8-A	MMS 10000	147	4392	2322	241	247					2070	237	622
SP 215-8	MMS 10000	147	4392	2322	241	247					2070	237	622
SP 215-9-AA	MMS 10000	170	4718	2498	276	276					2220	237	672
SP 215-9-A	MMS 10000	170	4718	2498	276	276					2220	237	672
SP 215-9	MMS 10000	170	4718	2498	276	276					2220	237	672
SP 215-10-AA	MMS 12000	190	4654	2674	276	276					1980	286	793
SP 215-10-A	MMS 12000	190	4654	2674	276	276					1980	286	793
SP 215-10	MMS 12000	190	4654	2674	276	276					1980	286	793
SP 215-11	MMS 12000	220	4990	2850	286	286					2140	286	853

* Maximum diameter of pump with one motor cable.

** Maximum diameter of pump with two motor cables.

The pump types above are also available in N-versions. See page 5. Dimensions as above.

SP 215-1-A to SP 215-9 are also available in R-versions. See page 5. Dimensions as above.

Other types of connection are possible by means of connecting pieces. See page 87.

Power curves

Submersible pumps
SP 215

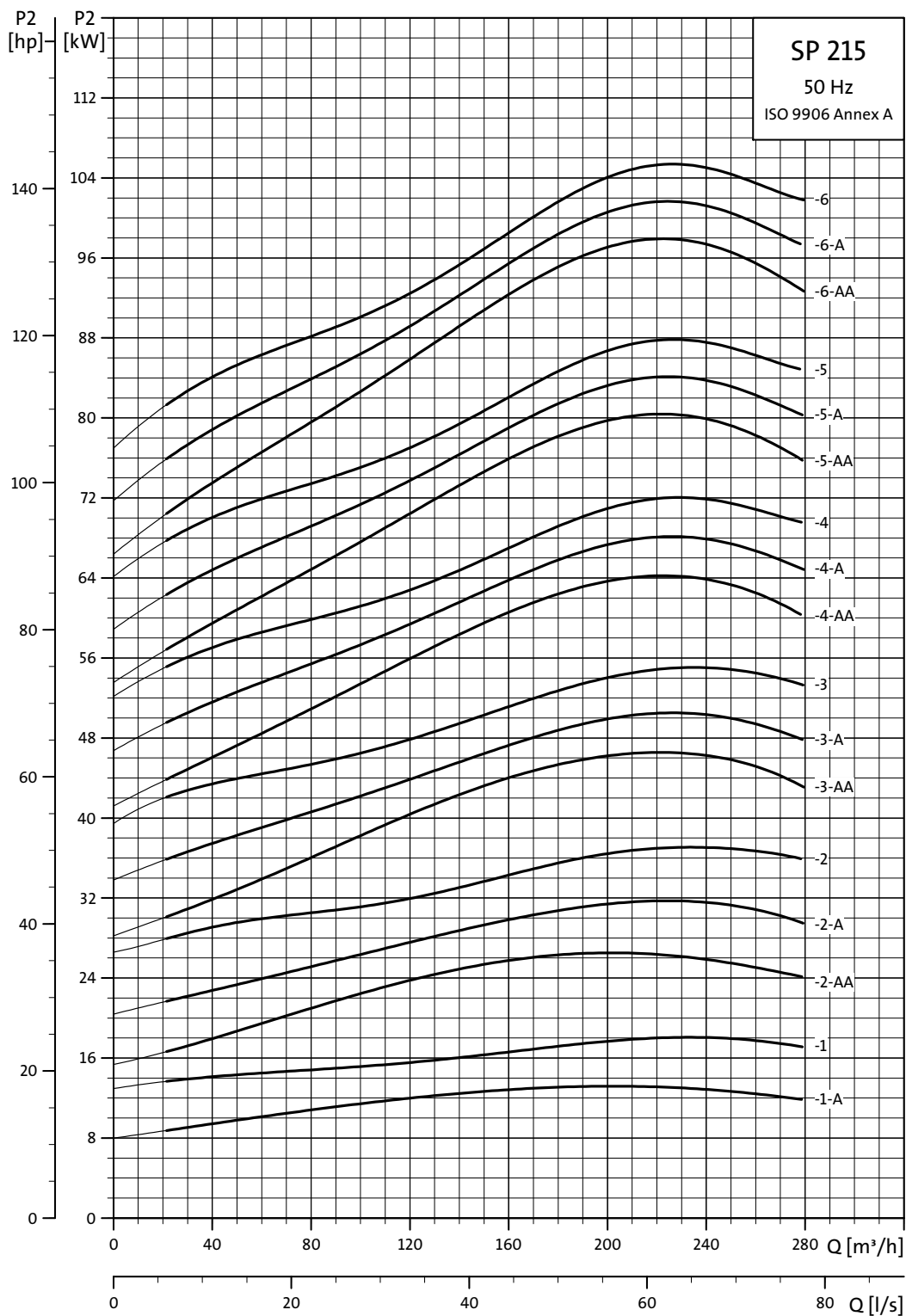

TM01 8787 4702

Power curves

Submersible pumps
SP 215

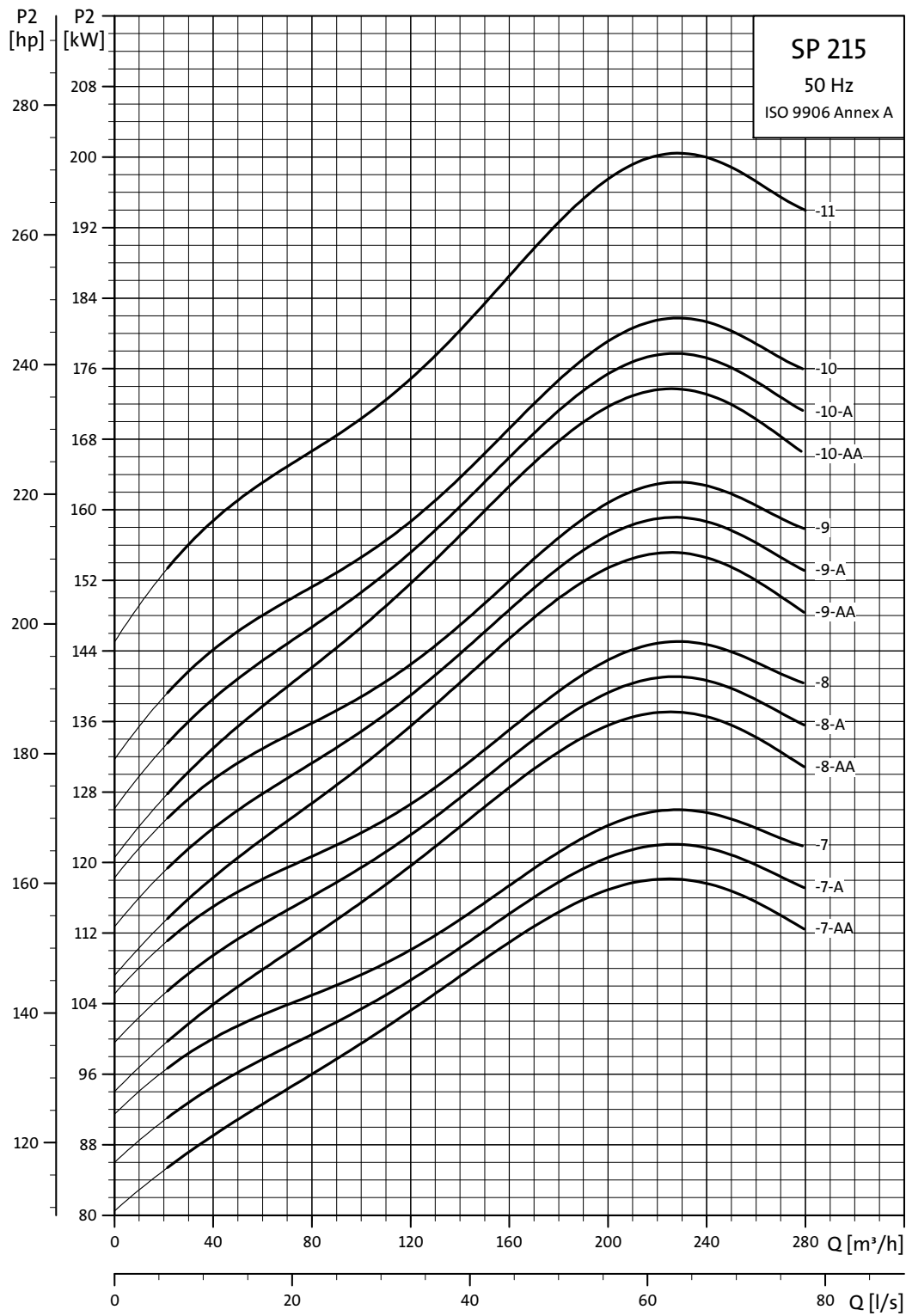

TIM01 8788 4702

1 x 230 V, submersible motors

Electrical data											Dimensions			
Motor		Full-load current I_n [A]	Motor efficiency [%]			Power factor			I_{st}/I_n	Control box for 3-wire motors	Capacitor for PSC motors	Length [mm]	Weight [kg]	
Type	Size		Power [kW]	η_{50} %	η_{75} %	η_{100} %	Cos ϕ 50 %	Cos ϕ 75 %						Cos ϕ 100 %
MS 402	4"	0.37	3.95	48.0	54.0	57.0	0.58	0.68	0.77	3.4*	SA-SPM 2	16 μ F, 400 V, 50 Hz	256	6.8
MS 402	4"	0.55	5.80	49.5	56.5	59.5	0.52	0.65	0.74	3.5*	SA-SPM 2	20 μ F, 400 V, 50 Hz	291	8.2
MS 402	4"	0.75	7.45	52.0	58.0	60.0	0.57	0.69	0.79	3.6*	SA-SPM 2	30 μ F, 400 V, 50 Hz	306	8.9
MS 402	4"	1.1	7.30	62.0	69.5	72.5	0.99	0.99	0.99	4.3*	SA-SPM 3	40 μ F, 400 V, 50 Hz	346	10.5
MS 402	4"	1.5	10.2	56.5	66.5	71.0	0.91	0.96	0.98	3.9	SA-SPM 3		346	11.0
MS 4000 (R)	4"	2.2	14.0	67.0	73.0	75.0	0.91	0.94	0.96	4.4	SA-SPM 3		576	21.0

* Applies to 3-wire motors.

MS 402 2-wire motors incorporate motor protection and can therefore be connected directly to the mains.

3 x 230 V, submersible motors

Electrical data											Dimensions	
Motor		Full-load current I_n [A]	Motor efficiency [%]			Power factor			I_{st}/I_n	Length [mm]	Weight [kg]	
Type	Size		Power [kW]	η_{50} %	η_{75} %	η_{100} %	Cos ϕ 50 %	Cos ϕ 75 %				Cos ϕ 100 %
MS 402	4"	0.37	2.55	51.0	59.5	64.0	0.44	0.55	0.64	3.7	226	5.5
MS 402	4"	0.55	4.00	48.5	57.0	64.0	0.42	0.52	0.64	3.5	241	6.3
MS 402	4"	0.75	4.20	64.0	69.5	73.0	0.50	0.62	0.72	4.6	276	7.7
MS 4000 (R)	4"	0.75	3.35	66.8	71.1	72.9	0.66	0.76	0.82	5.1	401	13.0
MS 402	4"	1.1	6.20	62.5	69.0	73.0	0.47	0.59	0.72	4.6	306	8.9
MS 4000 (R)	4"	1.1	5.00	69.1	73.2	75.0	0.57	0.70	0.78	5.2	416	14.0
MS 402	4"	1.5	7.65	68.0	73.0	75.0	0.50	0.64	0.75	5.0	346	10.5
MS 4000 (R)	4"	1.5	7.40	66.6	71.4	72.9	0.53	0.66	0.74	4.5	416	14.0
MS 402	4"	2.2	10.0	72.5	75.5	76.0	0.56	0.71	0.82	4.7	346	11.9
MS 4000 (R)	4"	2.2	11.6	64.5	70.8	73.3	0.44	0.58	0.69	4.2	456	16.0
MS 4000 (R)	4"	3.0	14.6	67.5	72.8	74.6	0.48	0.62	0.73	4.4	496	17.0
MS 4000 (R)	4"	4.0	17.6	73.9	77.4	77.9	0.52	0.67	0.77	4.9	576	21.0
MS 4000 (R)	4"	5.5	24.2	76.0	78.8	79.6	0.51	0.66	0.76	4.9	676	26.0
MS6 (R)	6"	5.5	21.2	80.5	82.3	81.5	0.70	0.80	0.84	4.5	535	35.5
MS6 (R)	6"	7.5	28.5	80.5	82.6	82.1	0.68	0.78	0.84	5.0	565	37.0
MS6 (R)	6"	9.2	35.0	80.8	82.9	82.3	0.68	0.78	0.84	4.9	590	42.5
MS6 (R)	6"	11	43.0	80.3	82.7	82.6	0.62	0.76	0.82	4.9	683	45.5
MS6 (R)	6"	13	51.0	80.1	82.5	82.3	0.62	0.74	0.82	4.7	708	48.5
MS6 (R)	6"	15	58.5	80.8	83.1	82.9	0.62	0.76	0.82	4.7	738	52.5
MS6 (R)	6"	18.5	72.0	81.2	83.4	83.1	0.62	0.76	0.82	4.8	783	58.0
MS6 (R)	6"	22	85.0	81.7	83.8	83.7	0.62	0.76	0.82	5.0	838	64.0
MS6 (R)	6"	26	100	81.8	84.0	84.0	0.62	0.74	0.82	5.3	903	69.5
MS6 (R)	6"	30	110	82.3	84.2	83.7	0.66	0.78	0.84	5.2	968	77.5

MS 402: Data apply to 3 x 220 V.

3 x 230 V, submersible rewindable motors

Motor			Electrical data							Dimensions		
Type	Size	Power [kW]	Full-load current I_n [A]	Motor efficiency [%]			Power factor			I_{st}/I_n	Length [mm]	Weight [kg]
				$\eta_{50\%}$	$\eta_{75\%}$	$\eta_{100\%}$	$\cos \phi_{50\%}$	$\cos \phi_{75\%}$	$\cos \phi_{100\%}$			
MMS 6000 (-N)	6"	3.7	17.2	67	71	70	0.64	0.75	0.82	4.0	630	45
MMS 6000 (-N)	6"	5.5	24.2	75	76	74	0.63	0.75	0.81	3.7	660	48
MMS 6000 (-N)	6"	7.5	32.0	78	79	77	0.61	0.74	0.80	3.7	690	50
MMS 6000 (-N)	6"	9.2	38.5	77	78	77	0.64	0.76	0.82	3.6	720	55
MMS 6000 (-N)	6"	11	45.5	78	79	78	0.66	0.77	0.83	3.7	780	60
MMS 6000 (-N)	6"	13	52.5	81	82	80	0.65	0.77	0.82	3.8	915	72
MMS 6000 (-N)	6"	15	58.5	82	83	81	0.66	0.78	0.83	3.8	975	78
MMS 6000 (-N)	6"	18.5	67.0	85	85	83	0.76	0.85	0.88	5.3	1085	90
MMS 6000 (-N)	6"	22	79.5	85	85	84	0.75	0.84	0.87	5.2	1195	100
MMS 6000 (-N)	6"	26	100	84	85	84	0.63	0.76	0.83	4.7	1315	115
MMS 6000 (-N)	6"	30	112	85	85	84	0.66	0.78	0.84	4.8	1425	125
MMS 6000 (-N)	6"	37	146	85	86	84	0.59	0.73	0.80	4.8	1425	125
MMS6 (-N, -R)	6"	22	87.0	82	84	83	0.61	0.74	0.81	5.3	1087	95
MMS6 (-N, -R)	6"	26	106	81	83	83	0.57	0.70	0.78	5.6	1157	105
MMS6 (-N, -R)	6"	30	118	82	83	82	0.63	0.76	0.82	4.8	1212	110
MMS6 (-N, -R)	6"	37	148	82	84	83	0.59	0.72	0.81	5.4	1312	120
MMS 8000 (-N, -R)	8"	22	82.5	80	84	84	0.71	0.80	0.84	5.3	1010	126
MMS 8000 (-N, -R)	8"	26	95.5	81	84	84	0.76	0.83	0.86	5.1	1050	134
MMS 8000 (-N, -R)	8"	30	110	83	85	86	0.71	0.80	0.84	5.7	1110	146
MMS 8000 (-N, -R)	8"	37	134	83	86	86	0.73	0.82	0.85	5.7	1160	156
MMS 8000 (-N, -R)	8"	45	168	84	87	88	0.62	0.74	0.81	6.0	1270	177
MMS 8000 (-N, -R)	8"	55	214	84	87	88	0.57	0.70	0.77	5.9	1350	192
MMS 8000 (-N, -R)	8"	63	210	87	89	89	0.81	0.87	0.90	5.7	1490	218
MMS 10000 (-N, -R)	10"	75	270	84	86	86	0.72	0.81	0.85	5.4	1500	330
MMS 10000 (-N, -R)	10"	92	345	83	85	86	0.65	0.77	0.82	5.6	1690	385
MMS 10000 (-N, -R)	10"	110	385	85	86	86	0.80	0.86	0.88	5.7	1870	435

3 x 400 V, submersible motors

Motor			Electrical data							Dimensions		
Type	Size	Power [kW]	Full-load current I_n [A]	Motor efficiency [%]			Power factor			I_{st}/I_n	Length [mm]	Weight [kg]
				$\eta_{50\%}$	$\eta_{75\%}$	$\eta_{100\%}$	$\cos \phi_{50\%}$	$\cos \phi_{75\%}$	$\cos \phi_{100\%}$			
MS 402	4"	0.37	1.40	51.0	59.5	64.0	0.44	0.55	0.64	3.7	226	5.5
MS 402	4"	0.55	2.20	48.5	57.0	64.0	0.42	0.52	0.64	3.5	241	6.3
MS 402	4"	0.75	2.30	64.0	69.5	73.0	0.50	0.62	0.72	4.7	276	7.7
MS 4000R	4"	0.75	1.84	68.1	71.6	72.8	0.69	0.79	0.84	4.9	401	13.0
MS 402	4"	1.1	3.40	62.5	69.0	73.0	0.47	0.59	0.72	4.6	306	8.9
MS 4000R	4"	1.1	2.75	70.3	74.0	74.4	0.62	0.74	0.82	5.1	416	14.0
MS 402	4"	1.5	4.20	68.0	73.0	75.0	0.50	0.64	0.75	5.0	346	10.5
MS 4000R	4"	1.5	4.00	69.1	72.7	73.7	0.55	0.69	0.78	4.3	416	14.0
MS 402	4"	2.2	5.50	72.5	75.5	76.0	0.56	0.71	0.82	4.7	346	11.9
MS 4000 (R)	4"	2.2	6.05	67.9	73.1	74.5	0.49	0.63	0.74	4.5	456	16.0
MS 4000 (R)	4"	3.0	7.85	71.5	74.5	75.2	0.53	0.67	0.77	4.5	496	17.0
MS 4000 (R)	4"	4.0	9.60	77.3	78.4	78.0	0.57	0.71	0.80	4.8	576	21.0
MS 4000 (R)	4"	5.5	13.0	78.5	80.1	79.8	0.57	0.72	0.81	4.9	676	26.0
MS 4000 (R)	4"	7.5	18.8	75.2	78.2	78.2	0.52	0.67	0.78	4.5	776	31.0
MS6 (R)	6"	5.5	12.2	80.0	82.0	81.2	0.68	0.80	0.84	4.6	544	35.5
MS6 (R)	6"	7.5	16.6	80.5	82.6	82.0	0.68	0.80	0.84	5.0	574	37.0
MS6 (R)	6"	9.2	20.2	81.2	83.1	82.5	0.68	0.80	0.84	4.9	604	42.5
MS6 (R)	6"	11	24.6	80.6	82.7	82.3	0.64	0.78	0.84	4.8	634	45.5
MS6 (R)	6"	13	29.0	80.6	82.9	82.6	0.62	0.76	0.82	4.7	664	48.5
MS6 (R)	6"	15	33.5	81.0	83.2	82.8	0.64	0.76	0.82	4.6	699	52.5
MS6 (R)	6"	18.5	41.5	80.9	83.1	82.8	0.62	0.76	0.82	4.8	754	58.0
MS6 (R)	6"	22	48.5	81.7	83.7	83.4	0.64	0.76	0.84	4.9	814	64.0
MS6 (R)	6"	26	57.5	81.8	83.9	83.6	0.64	0.76	0.82	5.2	874	69.5
MS6 (R)	6"	30	65.0	82.4	84.3	83.8	0.66	0.78	0.84	5.3	944	77.5

3 x 400 V, submersible industrial motors

Motor		Electrical data							Dimensions			
Type	Size	Power [kW]	Full-load current I_n [A]	Motor efficiency [%]			Power factor			$\frac{I_{st}}{I_n}$	Length [mm]	Weight [kg]
				η_{50} %	η_{75} %	η_{100} %	Cos ϕ 50 %	Cos ϕ 75 %	Cos ϕ 100 %			
MS 4000 (R)	4"	2.2	5.9	72.5	76.5	77.0	0.59	0.71	0.80	5.0	496	17.0
MS 4000 (R)	4"	3.0	7.5	75.0	79.0	80.0	0.58	0.71	0.79	5.4	576	21.0
MS 4000 (R)	4"	4.0	9.75	75.5	79.5	79.5	0.67	0.78	0.84	5.3	676	26.0
MS 4000 (R)	4"	5.5	14.4	77.5	79.6	79.8	0.55	0.69	0.79	5.0	776	42.5

3 x 400 V, submersible motors

Motor		Electrical data							Dimensions			
Type	Size	Power [kW]	Full-load current I_n [A]	Motor efficiency [%]			Power factor			$\frac{I_{st}}{I_n}$	Length [mm]	Weight [kg]
				η_{50} %	η_{75} %	η_{100} %	Cos ϕ 50 %	Cos ϕ 75 %	Cos ϕ 100 %			
MS6 (R)T60	6"	5.5	11.8	80.6	83.3	83.3	0.72	0.82	0.86	5.5	565	38
MS6 (R)T60	6"	7.5	15.8	81.7	83.7	83.2	0.78	0.84	0.86	4.8	610	43
MS6 (R)T60	6"	9.2	19.4	81.9	84.0	83.7	0.76	0.84	0.86	4.9	635	46
MS6 (R)T60	6"	11	23.2	82.1	84.3	84.0	0.74	0.82	0.86	4.9	738	53
MS6 (R)T60	6"	13	27.0	82.4	84.5	84.1	0.76	0.84	0.86	5.0	783	58
MS6 (R)T60	6"	15	31.0	82.6	84.8	84.7	0.76	0.84	0.86	5.3	838	64
MS6 (R)T60	6"	18.5	38.5	82.9	85.0	84.8	0.76	0.84	0.86	5.5	903	71
MS6 (R)T60	6"	22	45.0	83.2	85.2	84.9	0.78	0.84	0.88	5.6	1023	84

3 x 400 V, submersible rewindable motors

Motor		Electrical data								Dimensions		
Type	Size	Power [kW]	Full-load current I _n [A]	Motor efficiency [%]			Power factor			I _{st} /I _n	Length [mm]	Weight [kg]
				η50 %	η75 %	η100 %	Cos φ 50 %	Cos φ 75 %	Cos φ 100 %			
MMS 6000 (-N)	6"	3.7	9.85	67	70	70	0.63	0.75	0.81	4.0	630	45
MMS 6000 (-N)	6"	5.5	14.0	75	76	74	0.62	0.75	0.81	3.7	660	48
MMS 6000 (-N)	6"	7.5	18.4	77	79	77	0.60	0.73	0.80	3.7	690	50
MMS 6000 (-N)	6"	9.2	22.4	77	78	77	0.64	0.76	0.81	3.6	720	55
MMS 6000 (-N)	6"	11	26.0	78	79	78	0.65	0.77	0.82	3.7	780	60
MMS 6000 (-N)	6"	13	30.0	81	81	80	0.64	0.76	0.82	3.8	915	72
MMS 6000 (-N)	6"	15	34.0	82	82	81	0.66	0.78	0.83	3.8	975	78
MMS 6000 (-N)	6"	18.5	40.5	83	85	84	0.64	0.77	0.83	5.3	1085	90
MMS 6000 (-N)	6"	22	47.5	84	85	84	0.65	0.77	0.83	5.2	1195	100
MMS 6000 (-N)	6"	26	56.0	85	85	84	0.68	0.79	0.85	4.7	1315	115
MMS 6000 (-N)	6"	30	64.0	85	85	84	0.67	0.79	0.84	4.8	1425	125
MMS 6000 (-N)	6"	37	80.0	84	85	83	0.66	0.77	0.83	4.3	1425	125
MMS6 (-N, -R)	6"	22	51.5	81	83	83	0.57	0.70	0.79	5.5	1087	95
MMS6 (-N, -R)	6"	26	61.0	81	83	83	0.57	0.70	0.78	5.7	1157	105
MMS6 (-N, -R)	6"	30	68.2	83	84	84	0.61	0.73	0.81	5.0	1212	110
MMS6 (-N, -R)	6"	37	84.5	82	84	83	0.60	0.73	0.81	5.1	1312	120
MMS 8000 (-N, -R)	8"	22	48.0	80	82	82	0.72	0.81	0.84	5.3	1010	126
MMS 8000 (-N, -R)	8"	26	56.5	80	82	82	0.76	0.83	0.85	5.1	1050	134
MMS 8000 (-N, -R)	8"	30	64.0	82	84	84	0.74	0.82	0.85	5.7	1110	146
MMS 8000 (-N, -R)	8"	37	78.5	82	84	84	0.74	0.82	0.85	5.7	1160	156
MMS 8000 (-N, -R)	8"	45	96.5	84	86	86	0.65	0.76	0.82	6.0	1270	177
MMS 8000 (-N, -R)	8"	55	114	84	86	86	0.72	0.81	0.85	5.9	1350	192
MMS 8000 (-N, -R)	8"	63	132	85	87	87	0.66	0.78	0.83	5.7	1490	218
MMS 8000 (-N, -R)	8"	75	152	86	87	87	0.71	0.82	0.86	5.8	1590	237
MMS 8000 (-N, -R)	8"	92	186	87	88	87	0.72	0.82	0.86	5.9	1830	283
MMS 8000 (-N, -R)	8"	110	224	86	87	87	0.73	0.83	0.87	5.8	2060	333
MMS 10000 (-N, -R)	10"	75	156	84	86	87	0.70	0.80	0.84	5.4	1400	280
MMS 10000 (-N, -R)	10"	92	194	84	87	87	0.67	0.78	0.82	5.6	1500	330
MMS 10000 (-N, -R)	10"	110	228	85	87	88	0.70	0.79	0.84	5.7	1690	385
MMS 10000 (-N, -R)	10"	132	270	85	88	88	0.71	0.81	0.84	5.7	1870	435
MMS 10000 (-N, -R)	10"	147	315	84	87	87	0.64	0.75	0.81	6.2	2070	500
MMS 10000 (-N, -R)	10"	170	365	84	86	87	0.64	0.75	0.81	6.0	2220	540
MMS 10000 (-N, -R)	10"	190	425	83	86	87	0.60	0.72	0.79	5.9	2400	580
MMS 12000 (N)	12"	147	305	84	87	88	0.66	0.77	0.83	6.2	1790	565
MMS 12000 (N)	12"	170	345	85	87	88	0.69	0.79	0.85	6.1	1880	605
MMS 12000 (N)	12"	190	390	85	87	88	0.68	0.79	0.84	6.2	1980	650
MMS 12000 (N)	12"	220	445	85	87	88	0.69	0.80	0.85	6.1	2140	700
MMS 12000 (N)	12"	250	505	85	87	88	0.69	0.80	0.85	5.9	2290	775

3 x 500 V, submersible motors

Motor			Electrical data							Dimensions		
Type	Size	Power [kW]	Full-load current I_n [A]	Motor efficiency [%]			Power factor			I_{st}/I_n	Length [mm]	Weight [kg]
				$\eta_{50\%}$	$\eta_{75\%}$	$\eta_{100\%}$	$\cos \varphi_{50\%}$	$\cos \varphi_{75\%}$	$\cos \varphi_{100\%}$			
MS 4000R	4"	0.75	1.5	69.1	72.7	73.7	0.55	0.69	0.78	4.7	401	13.0
MS 4000R	4"	1.1	2.2	70.3	74.0	74.4	0.62	0.74	0.82	5.0	416	14.0
MS 4000R	4"	1.5	3.2	69.1	72.7	73.7	0.55	0.69	0.78	4.4	416	14.0
MS 4000 (R)	4"	2.2	4.9	67.9	73.1	74.5	0.49	0.63	0.74	4.3	456	16.0
MS 4000 (R)	4"	3.0	6.3	71.5	74.5	75.2	0.53	0.67	0.77	4.6	496	17.0
MS 4000 (R)	4"	4.0	7.7	77.3	78.4	78.0	0.57	0.71	0.81	4.8	576	21.0
MS 4000 (R)	4"	5.5	10.4	78.5	80.1	79.8	0.57	0.72	0.81	4.9	676	26.0
MS 4000 (R)	4"	7.5	15.0	75.2	78.2	78.2	0.52	0.67	0.78	4.5	776	31.0
MS6 (R)	6"	5.5	9.55	82.6	82.6	81.5	0.82	0.86	0.86	430	565	38
MS6 (R)	6"	7.5	12.8	83.2	83.3	82.2	0.82	0.86	0.86	445	590	41
MS6 (R)	6"	9.2	15.6	83.3	83.4	82.3	0.80	0.86	0.86	440	610	43
MS6 (R)	6"	11	18.8	83.4	83.8	82.9	0.78	0.86	0.86	445	708	49
MS6 (R)	6"	13	22.0	83.7	84.0	83.1	0.78	0.86	0.86	430	738	53
MS6 (R)	6"	15	25.0	84.2	84.0	83.0	0.82	0.86	0.88	425	783	58
MS6 (R)	6"	18.5	31.0	84.5	84.2	83.1	0.82	0.86	0.88	430	838	64
MS6 (R)	6"	22	36.5	84.6	84.4	83.3	0.82	0.88	0.88	450	903	71
MS6 (R)	6"	26	43.5	84.7	84.6	83.6	0.82	0.86	0.88	470	968	78
MS6 (R)	6"	30	50.0	84.7	84.9	84.1	0.80	0.86	0.88	500	1023	84

3 x 500 V, submersible industrial motors

Motor			Electrical data							Dimensions		
Type	Size	Power [kW]	Full-load current I_n [A]	Motor efficiency [%]			Power factor			I_{st}/I_n	Length [mm]	Weight [kg]
				$\eta_{50\%}$	$\eta_{75\%}$	$\eta_{100\%}$	$\cos \varphi_{50\%}$	$\cos \varphi_{75\%}$	$\cos \varphi_{100\%}$			
MS 4000 (R)	4"	2.2	4.7	72.5	76.5	77.0	0.59	0.71	0.80	4.9	496	17.0
MS 4000 (R)	4"	3.0	6.2	75.0	79.0	80.0	0.58	0.71	0.79	5.4	576	21.0
MS 4000 (R)	4"	4.0	7.8	75.5	79.5	79.5	0.67	0.78	0.84	5.2	676	26.0
MS 4000 (R)	4"	5.5	11.6	77.0	79.5	80.0	0.55	0.68	0.78	5.0	776	31.0

3 x 500 V, submersible rewindable motors

Motor		Electrical data								Dimensions		
Type	Size	Power [kW]	Full-load current I_n [A]	Motor efficiency [%]			Power factor			$\frac{I_{st}}{I_n}$	Length [mm]	Weight [kg]
				$\eta_{50\%}$	$\eta_{75\%}$	$\eta_{100\%}$	Cos ϕ 50 %	Cos ϕ 75 %	Cos ϕ 100 %			
MMS 6000 (-N)	6"	7.5	14.4	78	78	74	0.73	0.82	0.85	3.2	690	50
MMS 6000 (-N)	6"	9.2	17.4	77	78	76	0.69	0.80	0.84	3.4	720	55
MMS 6000 (-N)	6"	11	15.0	79	79	77	0.71	0.81	0.85	4.7	780	60
MMS 6000 (-N)	6"	13	23.4	82	82	80	0.69	0.98	0.84	3.7	915	72
MMS 6000 (-N)	6"	15	26.5	83	83	80	0.76	0.84	0.86	4.2	975	78
MMS 6000 (-N)	6"	18.5	31.5	84	85	84	0.70	0.81	0.85	5.2	1085	90
MMS 6000 (-N)	6"	22	36.5	85	86	84	0.77	0.85	0.87	4.9	1195	100
MMS 6000 (-N)	6"	26	44.5	85	85	84	0.68	0.79	0.85	4.8	1315	115
MMS 6000 (-N)	6"	30	50.5	86	86	84	0.72	0.82	0.86	4.7	1425	125
MMS 6000 (-N)	6"	37	63.0	86	86	85	0.68	0.79	0.84	4.9	1425	125
MMS6 (-N, -R)	6"	22	39.5	82	82	80	0.69	0.80	0.84	4.8	1087	95
MMS6 (-N, -R)	6"	26	47.0	81	82	80	0.67	0.79	0.84	5.0	1157	105
MMS6 (-N, -R)	6"	30	54.5	80	81	79	0.67	0.79	0.84	4.5	1212	110
MMS6 (-N, -R)	6"	37	66.5	81	82	80	0.66	0.78	0.85	5.1	1312	120
MMS 8000 (-N, -R)	8"	22	37.5	81	83	83	0.79	0.85	0.87	4.7	1010	126
MMS 8000 (-N, -R)	8"	26	44.0	81	84	83	0.80	0.85	0.86	4.8	1050	134
MMS 8000 (-N, -R)	8"	30	49.5	83	85	85	0.78	0.85	0.86	5.6	1110	146
MMS 8000 (-N, -R)	8"	37	60.5	84	85	85	0.82	0.87	0.87	5.6	1160	156
MMS 8000 (-N, -R)	8"	45	72.0	85	87	87	0.73	0.82	0.86	6.2	1270	177
MMS 8000 (-N, -R)	8"	55	88.5	86	88	88	0.71	0.81	0.86	6.1	1350	192
MMS 8000 (-N, -R)	8"	63	96.5	87	89	88	0.82	0.88	0.90	6.1	1490	218
MMS 8000 (-N, -R)	8"	75	114	88	89	88	0.85	0.89	0.90	5.6	1590	237
MMS 8000 (-N, -R)	8"	92	142	88	87	88	0.81	0.87	0.89	5.3	1830	283
MMS 8000 (-N, -R)	8"	110	182	86	88	88	0.67	0.78	0.84	5.3	2060	333
MMS 10000 (-N, -R)	10"	75	122	85	87	87	0.77	0.84	0.86	5.3	1400	280
MMS 10000 (-N, -R)	10"	92	150	85	87	87	0.74	0.82	0.85	5.3	1500	330
MMS 10000 (-N, -R)	10"	110	178	85	87	88	0.76	0.84	0.86	5.4	1690	385
MMS 10000 (-N, -R)	10"	132	210	86	88	87	0.82	0.87	0.88	5.0	1870	435
MMS 10000 (-N, -R)	10"	147	236	85	88	88	0.74	0.83	0.86	5.8	2070	500
MMS 10000 (-N, -R)	10"	170	270	86	88	88	0.78	0.85	0.87	5.4	2220	540
MMS 10000 (-N, -R)	10"	190	305	86	88	87	0.80	0.86	0.87	5.3	2400	580
MMS 12000 (N)	12"	147	218	86	89	90	0.80	0.88	0.91	6.9	1790	565
MMS 12000 (N)	12"	170	265	87	89	90	0.74	0.82	0.86	6.0	1880	605
MMS 12000 (N)	12"	190	220	88	90	91	0.85	0.91	0.93	7.8	1980	650
MMS 12000 (N)	12"	220	335	88	90	90	0.79	0.86	0.88	5.8	2140	700
MMS 12000 (N)	12"	250	375	87	90	91	0.75	0.85	0.89	6.3	2290	775

CUE frequency converter

The Grundfos CUE is a series of external frequency converters designed for speed control of a wide range of Grundfos pumps.

When a CUE is installed, the motor requires no further motor protection.

The CUE offers quick and easy set-up and commissioning compared to a standard frequency converter because of the start-up guide. Simply key in application-specific variables such as motor data, pump family, control function (e.g. constant pressure), sensor type, and setpoint, and the CUE will automatically set all necessary parameters.

The CUE enables gentle pumping and thereby protects the water reservoir and the rest of the distribution system, as water hammer can be avoided by adjusting ramp times up and down.

Overview of the CUE range

Supply voltage [V]	Power range [kW]						
	0.55	0.75	1.1	7.5	11	45	250
3 x 525-690							
3 x 525-600							
3 x 380-500							
3 x 200-240							
1 x 200-240							

The CUE is available in two enclosure classes:

- IP20/21
- IP54/55.

RFI filters

To meet the EMC requirements, the CUE comes with the following types of built-in radio frequency interference filter (RFI).

Voltage [V]	Typical shaft power, P2 [kW]	RFI filter type	Application
1 x 200-240	1.1 - 7.5	C1	Domestic
3 x 200-240	0.75 - 45	C1	
3 x 380-500	0.55 - 90	C1	
3 x 380-500	110 - 250	C2	Domestic/ industry
3 x 525-600	0.75 - 7.5	C3	Industry
3 x 525-690	11 - 25	C3	



GrA4404

Fig. 17 The CUE range

Functions

The CUE has a wide range of pump-specific functions, such as

- constant pressure
- constant level
- constant flow rate
- constant temperature
- constant curve.

CUE features

Start-up guide

The CUE incorporates an innovative start-up guide for the general setting of the CUE including the setting of the correct direction of rotation.

The start-up guide is started the first time when the CUE is connected to the power supply.

- Check of direction of rotation.
- Duty/standby operation.
- Dry-running protection.
- Low-flow stop function.

Inputs and outputs

The CUE incorporates various inputs and outputs:

- 1 RS-485 GENIbus connection
- 1 analog input, 0-10 V, 0/4-20 mA
 - external setpoint
- 1 analog input, 0/4-20 mA
 - sensor input, feedback sensor
- 1 analog output, 0-20 mA
- 4 digital inputs
 - start/stop and three programmable inputs
- 2 signal relays (C/NO/NC)
 - programmable.

Accessories for the CUE

Grundfos offers various accessories for the CUE.

MCB 114 sensor input module

The MCB 114 offers additional analog inputs for the CUE:

- 1 analog input, 0/4-20 mA
- 2 inputs for Pt100 and Pt1000 temperature sensors.

Output filters

Output filters are used primarily to protect the motor against overvoltage and increased operating temperature. However, output filters can also be used to reduce acoustic noise from the motor.

Grundfos offers two types of output filter as accessories for the CUE:

- dU/dt filters
- sine-wave filters.

Floor-mounting option

The CUE is as standard installed on the wall. The enclosures D1 and D2 can also be installed on the floor on a pedestal designed for that purpose.

For information about enclosures, see the product-specific documentation for the CUE.

IP21/NEMA1 option

An IP20 enclosure can be upgraded to IP21/NEMA1 by using the IP21/NEMA1 option. The power terminals (mains and motor) will be covered.

Sensors

The following sensors can be used in connection with the CUE. All sensors are with 4-20 mA output signal.

- Pressure sensors, up to 25 bar
- temperature sensors
- differential-pressure sensors
- differential-temperature sensors
- flowmeters
- potentiometer box for external setpoint setting.

Gateways

The CUE has a standard RS-485 GENIbus interface. Gateways to convert to other bus standards are available as accessories.

The CIU family (CIU = Communication Interface Units) can convert from GENIbus to the most common fieldbuses in the world:

- CIU 100 converts from GENIbus to LonWorks
- CIU 150 converts from GENIbus to Profibus DP
- CIU 200 converts from GENIbus to Modbus RTU
- CIU 250 is a GSM modem which can send SMS messages in case of alarms, etc.

Control MPC

Control MPC, a multi-pump control system for the control of parallel-connected CUE pump solutions.

Use of output filters

The table below shows in which cases an output filter is required. From the table, it can be seen if a filter is needed, and which type to use.

The selection depends on these factors:

- pump type
- motor cable length
- the required reduction of acoustic noise from the motor.

Pump type	Typical shaft power P ₂	dU/dt filter	Sine-wave filter
SP with 380 V motor and up	Up to 7.5 kW	-	0-300 m
	11 kW and up	0-150 m	150-300 m

The lengths stated apply to the motor cable.

Cables used in CUE installations

Note: When the CUE is installed in connection with SP pumps, we distinguish between two types of installation:

- installation in EMC-insensitive sites. See fig. 18.
- installation in EMC-sensitive sites. See fig. 19.

The two types of installation are different when it comes to the use of screened cable.

Note: Drop cables are always unscreened.

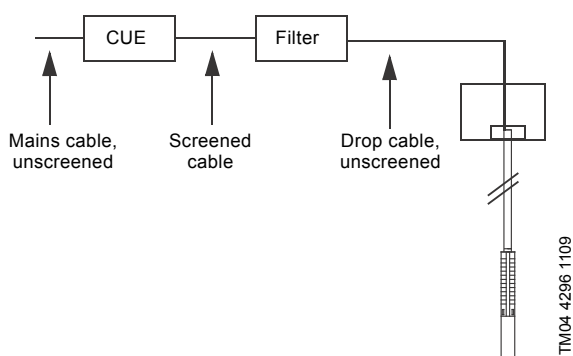

Fig. 18 Example of installation in EMC-insensitive sites

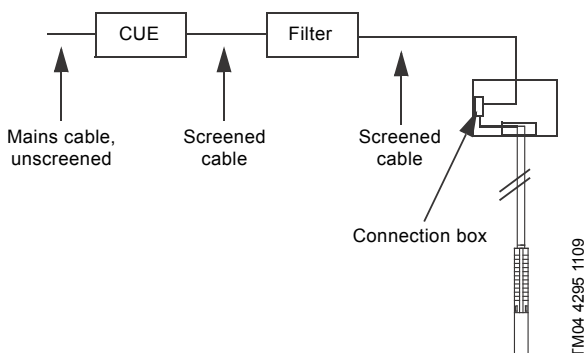

Fig. 19 Example of installation in EMC-sensitive sites

Screened cables are required in those parts of the installation where the surroundings must be protected against EMC.

The CUE is the right choice of frequency converter in SP installations as it meets all basic issues. The CUE has a pre-installed start-up guide which takes the installer through all the necessary settings.

The table below shows the different issues to be considered when using frequency converters in SP installations.

Issues to be considered	Explanation
Ramp (up and down): Maximum 3 seconds.	The journal bearings must be lubricated in order to limit wear and overheating of windings.
Use temperature monitoring by Pt sensor.	Overheating of the motor => low insulation resistance => sensitive to voltage peaks.
Reduce peak voltages (max. 800 V peaks).	Never exceed peak voltages of 850 V at motor leads.
For MS and MMS, we recommend to use motors with 10 % extra in given duty point. For MMS, always use motors (PE2 - PA wound).	Grundfos CUE with output filter is a safe solution.
Remember output filter.	Cables act as an amplifier => measure peaks at the motor.
Rise time (dU/dt) shall be limited to a maximum of 1000 V/μs. Determined by the equipment in the CUE.	Time between switches is an expression of losses, so in the future, we might have to exceed the limit of 1000 V/μs. The solution is not higher insulation of the motor, but filter in the output from the CUE.
Min. 30 Hz. Use a 60 Hz motor for larger range.	Too low speed => no lubrication of journal bearings.
Size the CUE in respect of the current, not the power output.	Can end up with a too small CUE.
Size cooling provision for stator tube at duty point with lowest flow rate.	Flow min. m/s along the stator housing must be considered.
Ensure that the pump is used within the range of the pump curve.	Focus on discharge pressure and sufficient NPSH, as vibrations will "kill" the motor.

MP 204 motor protector

The MP 204 is an electronic motor protector, designed for the protection of an asynchronous motor or a pump.

The MP 204 cannot be used in installations where a frequency converter is installed.

If one or more of the warning limits are exceeded, the motor continues to run, but the warnings will appear in the MP 204 display.

Some values only have a warning limit.

The warning can also be read out with the Grundfos R100 remote control.

If one of the trip limits is exceeded, the trip relay will stop the motor. At the same time, the signal relay is operating to indicate that the limit has been exceeded.

Applications

The MP 204 can be used as a stand-alone motor protector.

The MP 204 can be monitored via a Grundfos GENibus.

The MP 204 protects the motor primarily by measuring the motor current by means of a true RMS measurement.

The MP 204 is designed for single- and three-phase motors. In single-phase motors, the starting and run capacitors are also measured. $\cos \varphi$ is measured in both single- and three-phase systems.

Benefits

The MP 204 offers these benefits:

- suitable for both single- and three-phase motors
- dry-running protection
- overload protection
- very high accuracy
- made for submersible pumps.

The MP 204, many monitoring options

The MP 204 monitors the following parameters:

- insulation resistance before start-up
- temperature (Tempcon, Pt sensor and PTC/thermal switch)
- overload/underload
- overvoltage/undervoltage
- phase sequence
- phase failure
- power factor
- power consumption
- harmonic distortion
- operating hours and number of starts.



Fig. 20 MP 204

Five sizes of single-turn transformers, 120-999 A.

Note: Monitoring of motor temperature is not possible when single-turn transformers are used.



Fig. 21 Single-turn transformers

Product numbers

Product	Product number
MP 204	96079927
R100	625333

TM03 1471 2205

TM03 2033 3505

Functions

- Phase-sequence monitoring
- indication of current or temperature (user selection)
- indication of temperature in °C or °F (user selection)
- 4-digit, 7-segment display
- setting and status reading with the R100
- setting and status reading via the GENIbus.

Tripping conditions

- Overload
- underload (dry running)
- temperature (Tempcon sensor, PTC/thermal switch and Pt sensor)
- phase failure
- phase sequence
- overvoltage
- undervoltage
- power factor ($\cos \varphi$)
- current unbalance.

Warnings

- Overload
- underload
- temperature (Tempcon and Pt sensor)
- overvoltage
- undervoltage
- power factor ($\cos \varphi$)
Note: In connection with single- and three-phase connection.
- run capacitor (single-phase operation)
- starting capacitor (single-phase operation)
- loss of communication in network
- harmonic distortion.

Learning function

- Phase sequence (three-phase operation)
- run capacitor (single-phase operation)
- starting capacitor (single-phase operation)
- identification and measurement of Pt100/Pt1000 sensor circuit.

External current transformers

When fitted with external current transformers, the MP 204 can handle currents from 120 to 999 A. Grundfos can supply approved current transformers from stock (200/5A, 300/5A, 500/5A, 750/5A, 1000/5A).

Technical data, MP 204

Enclosure class	IP20
Ambient temperature	-20 °C to +60 °C
Relative air humidity	99 %
Voltage range	100-480 VAC
Current range	3-999 A
Frequency	50 to 60 Hz
IEC trip class	1-45
Special Grundfos trip class	0.1 to 30 s
Voltage variation	-25 % / +15 % of rated voltage
Approvals	EN 60947, EN 60335, UL/CSA 508
Marking	CE, cUL, C-tick
Consumption	Max. 5 W
Plastic type	Black PC / ABS

	Measuring range	Accuracy	Resolution
Current without external current transformers	3-120 A	± 1 %	0.1 A
Current with external current transformers	120-999 A	± 1 %	1 A
Phase-to-phase voltage	80-610 VAC	± 1 %	1 V
Frequency	47-63 Hz	± 1 %	0.5 Hz
Power	0-1 MW	± 2 %	1 W
Power factor	0 - 0.99	± 2 %	0.01
Energy consumption	0-4 x 10 ⁹ kWh	± 5 %	1 kWh

IO 112	Description	Product number
	<p>The IO 112 is a measuring module and a single-channel protection unit for use in connection with the MP 204 motor protector. The module can be used for protection of the pump against other factors than the electrical conditions, for instance dry running. It can also be used as a stand-alone protection module.</p> <p>The IO 112 interface has three inputs for measured values, one potentiometer for setting of limits and indicator lights indicating the following:</p> <ul style="list-style-type: none"> • measured value of the input • value of the limit set • alarm source • pump status. <p>Electrical data:</p> <ul style="list-style-type: none"> • Supply voltage: 24 VAC ± 10 %, 50/60 Hz or 24 VDC ± 10 %. • Supply current: Min. 2.4 A, max. 8 A. • Power consumption: Max. 5 W. • Ambient temperature: -25 °C to +65 °C. • Enclosure class: IP20. 	96651601

TM03 5811 3906

G100 gateway

The G100 gateway is used for communication with Grundfos products.

The G100 offers a wide selection of options for integration of Grundfos products provided with GENIbus interface into main control and monitoring systems.

The G100 enables a pump installation to meet future demands for optimum pump operation in terms of reliability, operating costs, centralisation and automation.



GR5940

Fig. 22 G100

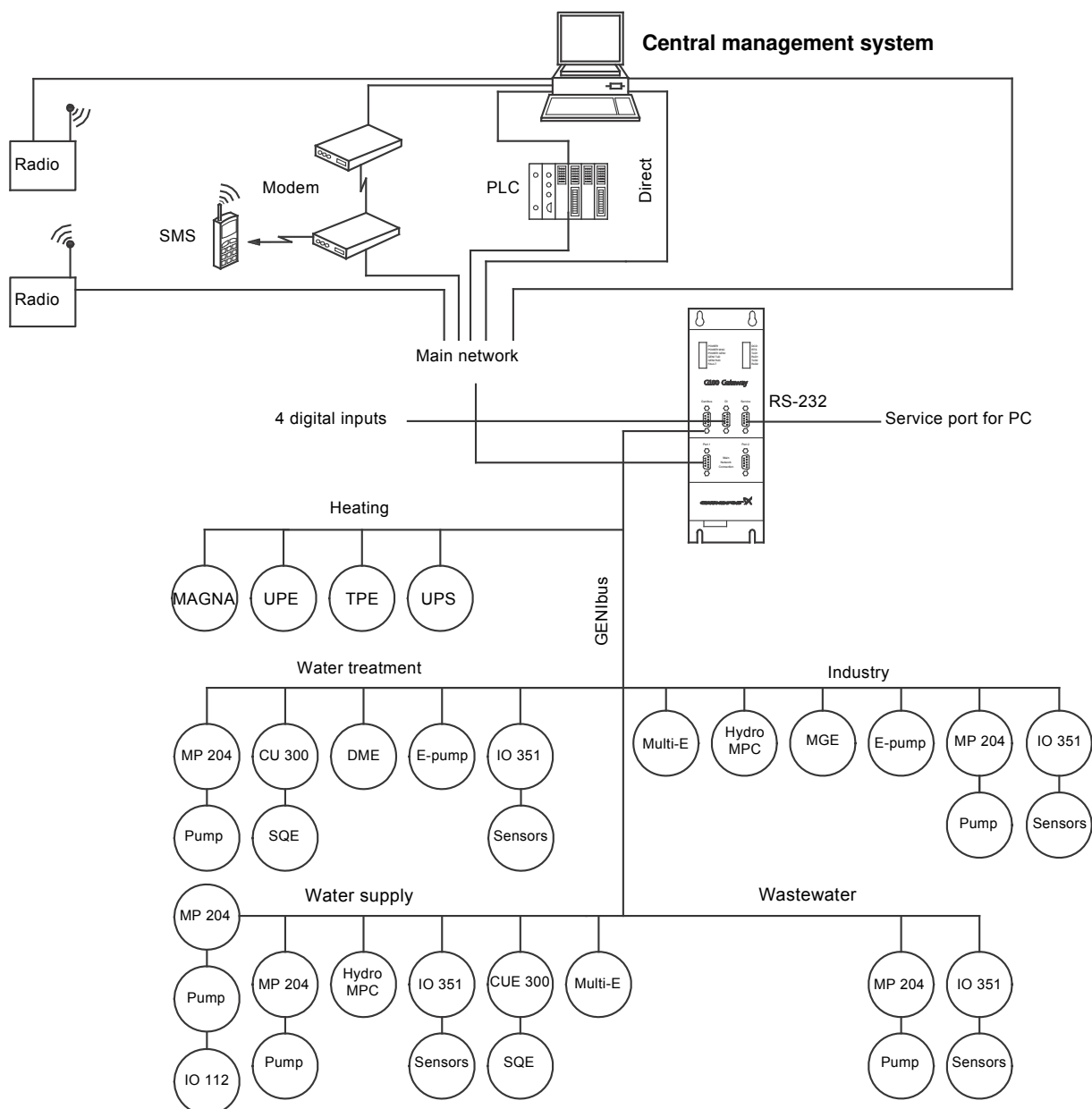

Fig. 23 Examples of G100 applications

TM03 9224 3607

Product description

The G100 gateway enables communication of operating data, such as measured values and setpoints, between Grundfos products with GENIbus interface and a main network for control and monitoring.

As indicated in the illustration on page 85, the G100 is suitable for use in applications such as water supply, water treatment, wastewater services, building automation and industry.

Common to the above applications is that downtime is usually costly, and extra investments are therefore often made to achieve maximum reliability by monitoring selected operating variables.

The day-to-day operation, such as starting and stopping of pumps and changing of setpoints, can also be effected from the main system by communication with the G100. In addition, the G100 can be set up to send event-controlled status indications such as alarms via SMS to mobile phones, and to make automatic alarm call-backs to a central management system.

Data logging

Besides data communication, the G100 offers logging of up to 350,000 time-stamped data. The logged data can be transmitted to the main system or a PC for further analysis in a spreadsheet or similar program.

For the data logging, the "PC Tool G100 Data Log" software tool is used. The tool is part of the PC Tool G100 package supplied with the G100.

Other features

- Four digital inputs.
- stop of all pumps in case of failing communication with the management system (optional).
- access code for modem communication (optional).
- alarm log.

Installation

Installation of the G100 is carried out by the system integrator. The G100 is connected to the GENIbus as well as to the main network. All units on the GENIbus can thus be controlled from a central management system on the main network.

The "G100 Support Files" CD-ROM supplied with the G100 contains examples of programs to be used when the G100 is connected to the various main network systems. Included is also a description of the data points available in Grundfos products with GENIbus interface.

The "PC Tool G100" software tool included can be used for the installation and use of the G100.

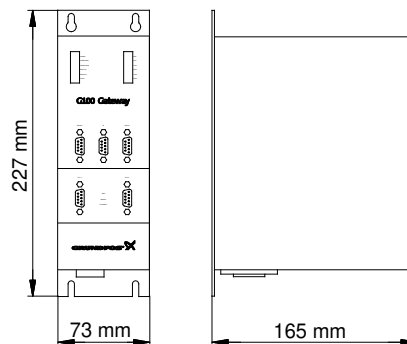

Fig. 24 Dimensional sketch

TM01 0621 1102

Technical data

Overview of protocols

Main system	Software protocol
Profibus-DP	DP
Radio	Satt Control COMLI/Modbus
Modem	Satt Control COMLI/Modbus
PLC	Satt Control COMLI/Modbus
GSM mobile phone	SMS, UCP

Other possible connections

- GENIbus RS-485: Connection of up to 32 units.
- Service port RS-232: For direct connection to a PC or via radio modem.
- Digital inputs: 4.
- Supply voltage: 1 x 110-240 V, 50/60 Hz.
- Ambient temperature: In operation: -20 °C to +60 °C.
- Enclosure class: IP20.
- Weight: 1.8 kg.

Accessories

- PC Tool G100 package (supplied with the product)
- G100 Support Files CD-ROM (supplied with the product).

Product numbers

Product	Product number
G100 with Profibus-DP expansion board*	96411135
G100 with Radio/Modem/PLC expansion board*	96411136
G100 Basic Version*	96411137
PC Tool G100 package	96415783

* CD-ROM with G100 Support Files included.

Connecting pieces

The tables below show the range of connecting pieces for connection of thread-to-flange and thread-to-thread.

Thread-to-flange

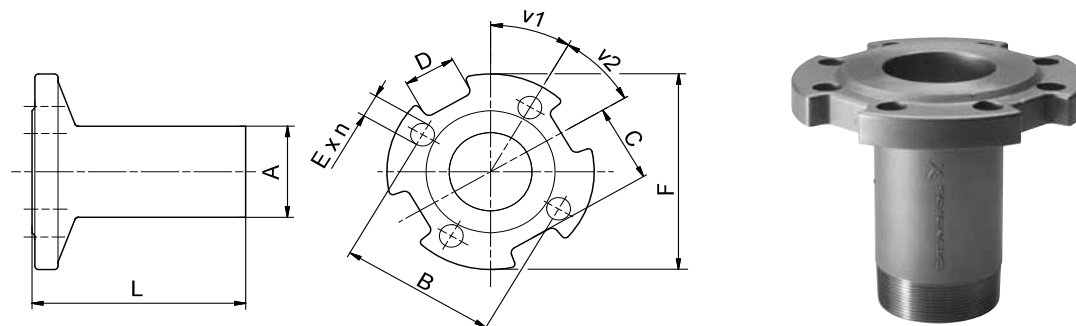

TM01 2396 4508 - GrA2552

Fig. 25 Dimensional sketch and photo of the connecting piece thread-to-flange

Type	Pump outlet	Connecting piece	Thread-to-flange										Product number	
			Dimensions [mm]										EN 1.4308	EN 1.4517
			A	B	C	D	E	F	L	v1	v2	n		
SP 17	Rp 2 1/2	R 2 1/2 → DN 50 PN 16/40	R 2 1/2	125	65	40	∅ 19	∅ 165	170	60	90	4	120125	120911
		R 2 1/2 → DN 65 PN 16/40	R 2 1/2	145	71	30	∅ 19	∅ 185	170	22.5	45	8	120126	120910
		R 2 1/2 → DN 80 PN 16/40	R 2 1/2	160	82.5	40	∅ 19	∅ 200	170	22.5	45	8	120127	120909
SP 30	Rp 3	R 3 → DN 65 PN 16/40	R 3	145	71	30	∅ 19	∅ 185	170	22.5	45	8	130187	130920
		R 3 → DN 80 PN 16/40	R 3	160	82.5	40	∅ 19	∅ 200	170	22.5	45	8	130188	130921
		R 3 → DN 100 PN 16/40	R 3	180/190	100	40	∅ 19/∅ 23	∅ 235	170	22.5	45	8	130189	130922
SP 46 SP 60	Rp 3 Rp 4	R 3 → DN 65 PN 16/40	R 3	145	71	30	∅ 19	∅ 185	170	22.5	45	8	130187	130920
		R 3 → DN 80 PN 16/40	R 3	160	82.5	40	∅ 19	∅ 200	170	22.5	45	8	130188	130921
		R 3 → DN 100 PN 16/40	R 3	180/190	100	40	∅ 19/∅ 23	∅ 235	170	22.5	45	8	130189	130922
SP 77 SP 95	Rp 5	R 4 → DN 100 PN 16/40	R 4	180/190	100	40	∅ 19/∅ 23	∅ 235	180	22.5	45	8	140071	140577
		R 5 → DN 100 PN 16/40	R 5	180/190	82	35	∅ 19/∅ 23	∅ 235	195	22.5	45	8	160148	160646
		R 5 → DN 125 PN 16/40	R 5	210/220	99	37	∅ 19/∅ 28	∅ 270	195	22.5	45	8	160149	160647
SP 125 SP 160 SP 215	Rp 6	R 5 → DN 150 PN 16/40	R 5	240/250	115	36	∅ 23/∅ 28	∅ 300	195	22.5	45	8	160150	160648
		R 6 → DN 125 PN 16/40	R 6	210/220	99	36	∅ 19/∅ 28	∅ 270	195	22.5	45	8	170159	170596
		R 6 → DN 150 PN 16/40	R 6	240/250	114	36	∅ 23/∅ 28	∅ 300	195	22.5	45	8	170160	170597
		R 6 → DN 200 PN 16	R 6	295	134	36	∅ 23	∅ 340	195	15	30	12	170161	170598
		R 6 → DN 200 PN 40	R 6	320	151	36	∅ 31	∅ 375	200	15	30	12	170162	170599

Thread-to-thread



TM01 2397 1698 - GrA2555

Fig. 26 Dimensional sketch and photo of the connecting piece thread-to-thread

Type	Pump outlet	Connecting piece	Dimensions			Product number		
			Thread-to-thread		L [mm]	EN 1.4301	EN 1.4401	EN 1.4539
			A	B				
SP 77 SP 95	Rp 5	R 5 → Rp 4	R 5	Rp 4	121	190063	190585	96917293
		R 5 → Rp 6	R 5	Rp 6	150	190069	190591	96917296
	5" NPT	5" NPT → 4" NPT	5" NPT	4" NPT	121	190064	190586	-
		5" NPT → 6" NPT	5" NPT	6" NPT	150	190070	190592	-
SP 125 SP 160 SP 215	Rp 6	R 6 → Rp 5	R 6	Rp 5	150	200130	200640	200971
	6" NPT	6" NPT → 5" NPT	6" NPT	5" NPT	150	200135	200645	-

Cable termination kit with plug

Product	Description	Version	Prod. no.
	For watertight joining of motor cable and submersible drop cable in an acrylic tube filled with resin. Used for both single- and multi-core cables during installation of submersible pumps. 24 hours of hardening is required.	MS 402 and MS 4000 up to 7.5 kW:	
		For cables up to 4 x 2.5 mm ²	799901
		For cables up to 4 x 6 mm ²	799902

TM00 7883 2296

Cable termination kit, type KM

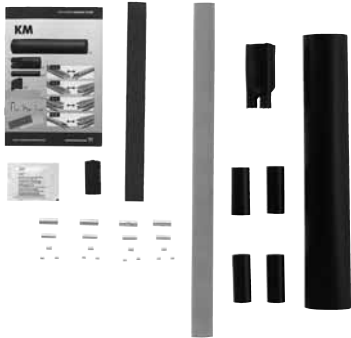
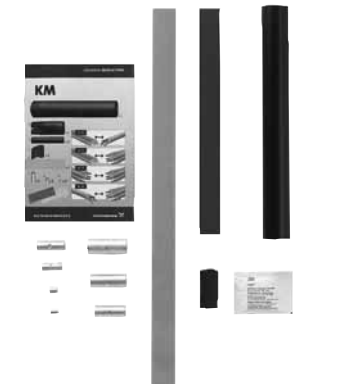
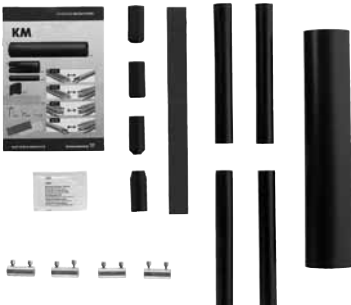
Product	Description	Version		Prod. no.	
		Motor cable	[mm ²]		Number of leads
	For watertight shrink-joining of motor cable and submersible drop cable. Enables the joining of <ul style="list-style-type: none"> • cables of equal size. • cables of different sizes. • a cable lead and a single-lead. The joint is ready for use after a few minutes and requires no long hardening time as do resin joints. The joint cannot be separated.	Flat cable	1.5 - 6.0	3	116251
			1.5 - 4.0	4	
		Flat cable	6 - 10	4	116252
	10 - 16	3			
Flat cable	16 - 25	3	116255		
		4			
	For watertight shrink-joining of motor cable and submersible drop cable. Enables the joining of <ul style="list-style-type: none"> • cables of equal size. • cables of different sizes. • a cable lead and a single-lead. The joint is ready for use after a few minutes and requires no long hardening time as do resin joints. The joint cannot be separated.	Single lead	10 - 70	1	96828296
		Single lead	35 - 120	1	116256
	For watertight joining of motor cable and submersible drop cable. By means of shrink-screw-glue casting.	Screw-shrinking	6 - 50	4	96636867
			19 - 95		96636868
			35 - 185		96637278
			70 - 240		96637279

TM04 4977 2309

TM04 4978 2309

TM04 4979 2309

Product	Description	Version		Prod. no.	
		Motor cable	Number of leads		
 <p style="text-align: right; margin-right: 20px;">TM04 4980 2309</p>	Reducing from 3 or 4 to one as from drop cable to single leads.	Reducer-shrinking	10 - 50	3	96637318
			10 - 50	4	96637330
			16 - 70	3	96637331
			16 - 70	4	96637332
		3 single leads	1.5 - 6.0	3	116253
		3 single leads	10 - 25	3	116254
		4 single leads	1.5 - 4.0	4	116257
		4 single leads	6 - 16	4	116258

Mastik for flat cables

Description	Prod. no.
Mastik for flat cables with separate earth, 48 pcs.	96788662

Cable termination kit, types M0 to M6

Product	Description	Version		Prod. no.	
		Type	Fit cables with outer diameter of		
 <p style="text-align: right; margin-right: 20px;">TM04 4981 2309</p>	For watertight joining of motor cable and submersible drop cable. The joint is encapsulated by the glue which is part of the kit.	Diameter of cable joint [mm]			
		M0	∅ 40	∅ 6 to ∅ 15	ID8903
		M1	∅ 46	∅ 9 to ∅ 23	ID8904
		M2	∅ 52	∅ 17 to ∅ 31	ID8905
		M3	∅ 77	∅ 26 to ∅ 44	ID8906
		M4	∅ 97	∅ 29 to ∅ 55	91070700
		M5	∅ 110	∅ 40 to ∅ 62	96496918
M6	∅ 144	∅ 50 to ∅ 80	96496919		

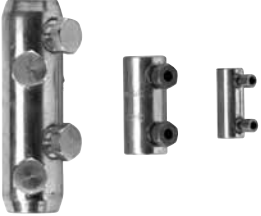
Product	Description	Version		Prod. no.
		Cross section of the leads [mm ²]	Number of connectors	
 <p style="text-align: right; margin-right: 20px;">GrA 8251</p>	Accessories for cable kit, types M0 to M6. Screw connectors only.	6-50	4	96626021
		19-95		96626022
		35-185		96626023
		70-240		96626028

Submersible drop cable

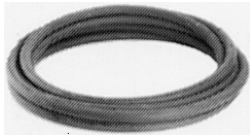
Product	Description	Number of leads and nominal cross section [mm ²]	Outer diameter min./max. [mm]	Weight [kg/m]	Product no.
 <p>TM00 7882 2296</p>	<p>Suitable for</p> <ul style="list-style-type: none"> • continuous application in groundwater and potable water (approved for potable-water applications) • connection of electrical equipment, such as submersible motors • installation depths up to 500 metres and average loads. <p>Insulation and sheath are made of special EPR-based elastomer materials adapted to applications in water.</p> <p>Maximum permissible water temperature: 60 °C. Maximum permissible lead service temperature: 90 °C.</p> <p>Further cable sizes are available on request.</p>	1 x 25	12.5 / 16.5	0.410	ID4072
		1 x 35	14.0 / 18.5	0.560	ID4073
		1 x 50	16.5 / 21.0	0.740	ID4074
		1 x 70	18.5 / 23.5	1.000	ID4075
		1 x 95	21.0 / 26.5	1.300	ID4076
		1 x 120	23.5 / 28.5	1.650	ID4077
		1 x 150	26.0 / 31.5	2.000	ID4078
		1 x 185	27.5 / 34.5	2.500	ID4079
		3 x 25	26.5 / 34.0	1.450	ID4062
		4G1.5	10.5 / 13.5	0.190	ID4063
		4G2.5	12.5 / 15.5	0.280	ID4064
		4G4.0	14.5 / 18.0	0.390	ID4065
		4G6.0	16.5 / 22.0	0.520	ID4066
		4G10	22.5 / 24.5	0.950	ID4067
		4G16	26.5 / 28.5	1.400	ID4068
		4G25	32.0 / 34.0	1.950	ID4069
		4G35	33.0 / 42.5	2.700	96432949
4G50	38.0 / 48.5	3.600	96432950		
4G70	43.0 / 54.5	4.900	96432951		

Zinc anodes

Application

Cathodic protection by means of zinc can be used for corrosion protection of SP pumps in chloride-containing liquids, such as brackish water and seawater.

Sacrificial anodes are placed on the outside of the pump and motor as protection against corrosion.

The number of anodes required depends on the pump and motor in question.

Please contact Grundfos for further details.

Liquid temperatures

Seawater: Up to 35 °C.

Brackish water (min. 1500 g/m³ chloride): Up to 35 °C.

Anode life

The zinc anodes have a life of one to four years, depending on operating conditions (temperature, flow and chloride content).

Product numbers of zinc anodes

Zinc anodes for pumps										
Product number	Used for pump type									
	SP 1A to SP 14A	SP 17	SP 30	SP 46	SP 60	SP 77	SP 95	SP 125	SP 160	SP 215
96421444	•									
96421445		•	•	•	•					
96421447						•	•			
96421448							•			
96421449								•		
96421450								•	•	•

Zinc anodes for motors				
4" motors	6" motors	8" motors	10" motors	12" motors
96421444	96421446	96421450	96564808	96421451

Flow sleeves

Grundfos offers a complete range of stainless-steel flow sleeves for both vertical and horizontal operation. Flow sleeves are recommended for all applications in which motor cooling is insufficient. The result is a general extension of motor life. Flow sleeves are to be fitted in these cases:

- If the submersible pump is exposed to high thermal load like current unbalance, dry running, overload, high ambient temperature, bad cooling conditions.
- If aggressive liquids are pumped, since corrosion is doubled for every 10 °C the temperature rises.
- If sedimentation or deposits occur around and/or on the motor.

Note: More information about flow sleeves is available on request.



TM01 0751 2197 - TM01 0750 2197

Fig. 27 Flow sleeves

SA-SPM control boxes

Application

SA-SPM control boxes are used as starting units for single-phase, 3-wire motors, types MS 402B and MS 4000.

The **SA-SPM 2** is used for single-phase MS 402B motors with a power input lower than or equal to 0.75 kW.

The **SA-SPM 3** is used for single-phase MS 402B and MS 4000 motors with a power input higher than or equal to 1.1 kW. The SA-SPM 3 incorporates a motor-protective circuit breaker and thus protects the motor against overload.

Technical data

Enclosure class: IP42.

Ambient temperature: -20 °C to +60 °C.

Relative humidity: Maximum 95 %, normal non-aggressive atmosphere.

Product numbers

Product number 50 Hz	SA-SPM control box							
	1 x 220-230 V		1 x 240 V		MS 402B		MS 4000	
	SA-SPM 2	SA-SPM 3	0.37 kW	0.55 kW	0.75 kW	1.1 kW	1.5 kW	2.2 kW
82219512	•	•	•					
82219513	•	•		•				
82219514	•	•			•			
82219315	•	•				•		
82219306	•	•					•	
82219307	•	•						•
82249512	•	•	•					
82249513	•	•		•				
82249514	•	•			•			
82249315	•	•				•		
82249306	•	•					•	
82249307	•	•						•

Capacitors for MS 402B PSC

MS 402B PSC motors must be connected to the mains via a run capacitor that is permanently connected during operation.

Product numbers

Capacitors for MS 402B PSC			
Capacitor size	Power [kW]	Capacitor Product no.	Control box Product no.
16 µF, 400 V, 50 Hz	0.37	ID2970	96023791
20 µF, 400 V, 50 Hz	0.55	ID2971	96023792
30 µF, 400 V, 50 Hz	0.75	ID2973	96023793
40 µF, 400 V, 50 Hz	1.1	ID2974	96023794

Pt100 sensor

The Pt100 sensor offers these features

- continuous monitoring of the motor temperature
- protection against too high motor temperature.

Protecting the motor against too high motor temperature is the simplest and cheapest way of avoiding that the motor lifetime is reduced. The Pt100 ensures that the operating conditions are not exceeded and indicates when it is time for service of the motor.

Monitoring and protection by means of a Pt100 require the following parts:

- Pt100 sensor
- PR 5714 relay
- cable.

The PR 5714 relay is fitted with a Pt100 sensor. The following temperature limits are preset on delivery:

- 60 °C warning limit
- 75 °C stop limit.

Technical data

Relay type	
PR 5714	
Enclosure class	IP65 (mounted in a control panel)
Ambient temperature	-20 °C to +60 °C
Relative humidity	95 % (condensating)
Voltage variation	• 1 x 24-230 VAC ± 10 %, 50-60 Hz • 24-250 VDC ± 20 %
Approvals	UL, DNV
Marking	CE

Pt100 sensor with/without PR 5714 relay and cable	Cable length [m]	PR 5714	Product number		
			MS6	MMS 6000 MMS 8000	MMS 10000 MMS 12000
	20	Yes	96408953	96494596	96437287
	40	Yes	96408681	96494597	96437288
	60	Yes	96408954	96494598	96437289
	80	Yes	96408955	96494599	96437290
	100	Yes	96408956	96494610	96437291
	20	No	96658626	96658629	96658633
	40	No	96658627	96658630	96658634
	60	No	96658628	96658631	96658635
	80	No	96658637	96658632	96658636
	100	No	96658638	96658639	96658640

GrA3187

PR 5714 relay	Voltage	Product number
	24-230 VAC, 50/60 Hz / 24-250 VDC	96913234



GrA3186

Pt100 sensor, including cable	Cable length [m]	Product number	
		MS6 MMS 6000 MMS 8000	MMS 10000 MMS 12000
	20	96913237	96913264
	40	96913253	96913265
	60	96913256	96913268
	80	96913260	96913269
	100	96913263	96913313

GrA3190

Staybolt kits for Pt100 in MS6 and MS 6000	Description	Product number
	Staybolt kit for Pt100. Suitable for MS 6000 model A, MS 6000 model B and MS6. Material: EN 1.4401/AISI 904.	96803373
	Staybolt kit for Pt100. Suitable for MS6 and MS 6000 model B. Material: EN 1.4539/AISI 316.	97550639

GrA3191

Insertion probe, MMS 10000 and MMS 12000	Description	Product number
	<p style="writing-mode: vertical-rl; transform: rotate(180deg);">TM04 3560 4508</p> <p>Insertion probe to be used for Pt100 in MMS 10000 and MMS 12000.</p>	96913215
Extension kit for sensor cable for Pt100	Description	Product number
	<p style="writing-mode: vertical-rl; transform: rotate(180deg);">TM00 7885 2296</p> <p>Extension kit for Pt100 sensor cable. For watertight shrink-joining of the sensor cable. Extra sensor cable must be ordered separately.</p>	96571480
Sensor cable	Description	Product number
	<p style="writing-mode: vertical-rl; transform: rotate(180deg);">TM00 7882 2296</p> <p>Drop cable for extension. Mention length when ordering. Maximum recommended length: 350 m.</p>	RM5271

Pt1000 sensor

The Pt1000 sensor offers these features

- continuous monitoring of the motor temperature
- protection against too high motor temperature.

Protecting the motor against too high motor temperature is the simplest and cheapest way of avoiding that the motor lifetime is reduced. The Pt1000 ensures that the operating conditions are not exceeded and indicates when it is time for service of the motor.

Monitoring and protection by means of a Pt1000 require the following parts:

- Pt1000 sensor
- CU 220 control unit
- cable
- staybolt kit for Pt1000.

The CU 220 control unit is fitted with a Pt1000 sensor. The following temperature limits are preset on delivery:

- 50 °C warning limit
- 60 °C stop limit.

The Pt1000 sensor works within the temperature range of -60 °C to +120 °C.

Technical data

CU 220	
Enclosure class	IP65 (mounted in a control panel)
Ambient temperature	0 °C to +55 °C
Relative humidity	20-80 % (condensating)
Voltage variation	1 x 230 V -15 % / +10 %, 50 Hz
Approvals	UR
Marking	CE

Pt1000 sensor with CU 220 control unit, cable and staybolt or insertion probe	Cable length [m]	CU 220	Product number		
			MS6	MMS 6000 MMS 8000	MMS 10000 MMS 12000
	20	Yes	96803207	96803233	96803238
	40	Yes	96803241	96803252	96803253
	60	Yes	96803254	96803255	96803257
	80	Yes	96803258	96803292	96803294
	100	Yes	96803301	96803312	96803313

TM04 3561 4508 - TM04 3563 450
TM04 3562 4508 - TM04 3560 4508

CU 220 control unit	Voltage	Product number
	1 x 230 V -15 % / +10 %, 50 Hz	96797484



TM04 3561 4508

Pt1000 sensor including cable	Cable length [m]	Product number
		MS6 MMS 6000 MMS 8000 MMS 10000 MMS 12000
	20	96804042
	40	96804044
	60	96804064
	80	96804065
	100	96804067

TM04 3563 4508

Staybolt kits for Pt1000 in MS6 and MS 6000	Description	Product number
	Staybolt kit for Pt1000. Suitable for MS 6000 model A, MS 6000 model B and MS6. Material: EN 1.4401/AISI 904.	96803373
	Staybolt kit for Pt1000. Suitable for MS6 and MS 6000 model B. Material: EN 1.4539/AISI 316.	97550639

GrA3191

Insertion probe for MMS 10000 and MMS 12000	Description	Product number
	<p style="text-align: center;">TM04 3560 4508</p> <p>Insertion probe to be used for Pt1000 in MMS 10000 and MMS 12000.</p>	96913215
Extension kit for sensor cable for Pt1000	Description	Product number
	<p style="text-align: center;">TM00 7885 2296</p> <p>Extension kit for Pt1000 sensor cable. For watertight shrink-joining of the sensor cable. Extra sensor cable must be ordered separately.</p>	96571480
Sensor cable	Description	Product number
	<p style="text-align: center;">TM00 7882 2296</p> <p>Drop cable for extension. Mention length when ordering. Maximum recommended length: 350 m.</p>	RM5271

Energy consumption of submersible pumps

The percentage distribution of service life costs of a submersible pump for water supply is as follows:

- 5 % initial costs (pump)
- 85 % operating costs / energy consumption
- 10 % maintenance costs.

It is obvious that the highest savings can be achieved within energy consumption!

The annual energy consumption, E, of a submersible pump can be calculated as follows:

$$E = c \times h \times P_1 \text{ (EURO)}$$

c = specific energy price (EURO/kWh)

h = operating hours/year (hours)

P₁ = power input of the submersible pump (kW).

Example: Calculation of the annual energy consumption of the submersible pump, type SP 125-3.

SP 125-3 with MS6, 30 kW, 3 x 400 V, 50 Hz.

Duty point:

Flow rate: Q = 120 m³/h

Total head: H = 63 m

Specific energy price: c = EURO 0.1/kWh
(consisting of day and night rate)

Operating hours/year: h = 3200.

$$P_1 = \frac{Q \times H \times \rho}{367 \times \eta_{\text{pump}} \times \eta_{\text{motor}}} \text{ in kW}$$

Q = m³/h

H = m

Density ρ = kg/dm³ (assumed 1)

367 = conversion factor

η_{pump} = (not to be confused with the stage efficiency curve)

η_{motor} = (example 84.5 %, in equation 0.845)

By showing the P₂/Q curve we make it easier for you to calculate the energy consumption.

$$P_1 = \frac{P_2}{\eta_{\text{motor}}}$$

P₂ = 26 kW (power requirement of SP 125-3 pump at 120 m³/h, from curve P₂/Q on page 58).

Calculation of motor efficiency at duty point

As standard, the SP 125-3 is fitted with a 30 kW MS6 motor.

At duty point (Q = 120 m³/h), the pump requires 26 kW, thus:

a motor load of 87 % (26 kW/30 kW) and a power reserve of 13 %.

From the table on page 73, the motor efficiency can be read as:

85 % at a load of 75 % (η_{75%})

84 % at a load of 100 % (η_{100%})

The interpolated value in this example is

η_{motor} = 84.5 %, η_{motor} = 0.845.

$$P_1 = \frac{26}{0.845} = 30.77 \text{ kW}$$

E = 0.1 EURO/kWh x 3200 h x 30.77 kW.

The annual energy costs amount to EURO 9846.

If we compare the energy costs of this energy-efficient Grundfos submersible pump with a submersible pump, type SP 120-4, from 1995, (Q = 110 to 120 m³/h; H = 63 to 58 m; η_{motor} = 82 %), we see that at the same annual total flow of 384,000 m³ and the same current price of 0.1 EURO/kWh, the annual energy consumption of the old pump amounts to EURO 12,777.

Wear and deposits on the motor and the pump were not taken into account.

The pay-off time, A, (months) is calculated as follows:

$$A = \frac{\text{Purchase price of energy - efficient pump}}{\text{Energy savings/year}} \times 12$$

The purchase price of the energy-efficient pump is EURO 4,090.

$$A = \frac{4090}{(\text{EURO } 12,777 - \text{EURO } 9,846)} \times 12 = 16.7 \text{ months}$$

The pay-off time is 16.7 months.

Note: The complete system should be sized for energy efficiency (cable/discharge pipes).

Cable sizing

In order to obtain an economical duty of the pump, the voltage drop should be low.

Today large water works already size cables for a maximum voltage drop of 1 %.

The hydraulic resistance in the discharge pipe should be as low as possible.

Cables

Grundfos offers submersible drop cables for all applications: 3-core cable, 4-core cable, single leads.

Cables for Grundfos 4" submersible motors are available with or without plugs. The submersible drop cable is chosen according to application and type of installation.

Standard version: Max. liquid temperature +60 °C.

Hot-water version: Max. liquid temperature +70 °C, for short periods up to +90 °C (for MS only).

Tables indicating cable dimension in borehole

The tables indicate the maximum length of drop cables in metres from motor starter to pump at direct-on-line starting at different cable dimensions.

If star-delta starting is used, the current will be reduced by $\sqrt{3}$ ($I \times 0.58$), meaning that the cable length may be $\sqrt{3}$ longer ($L \times 1.73$) than indicated in the tables.

If for example the operating current is 10 % lower than the full-load current, the cable may be 10 % longer than indicated in the tables.

The calculation of the cable length is based on a maximum voltage drop of 1 % to 3 % of the rated voltage and a water temperature of maximum 30 °C.

In order to minimise operating losses, the cable cross-section may be increased compared to what is indicated in the tables. This is only economical if the borehole provides the necessary space, and if the operational time of the pump is long, especially if the operating voltage is below the rated voltage.

The table values are calculated on the basis of the formula:

Max. cable length of a single-phase submersible pump:

$$L = \frac{U \times \Delta U}{I \times 2 \times 100 \times (\cos\varphi \times \frac{\rho}{q} + \sin\varphi \times X_L)} \quad [\text{m}]$$

Max. cable length of a three-phase submersible pump:

$$L = \frac{U \times \Delta U}{I \times 1.73 \times 100 \times (\cos\varphi \times \frac{\rho}{q} + \sin\varphi \times X_L)} \quad [\text{m}]$$

Formula designations

U = Rated voltage [V]

ΔU = Voltage drop [%]

I = Rated current of the motor [A]

$\cos\varphi$ = Power factor

ρ = Specific resistance: 0.02 [$\Omega \text{ mm}^2$]

q = Cross-section of submersible drop cable [mm^2]

$\sin\varphi = \sqrt{1 - \cos^2\varphi}$

X_L = Inductive resistance: 0.078×10^{-3} [Ω/m]

Example

Motor size: 30 kW, MMS 8000

Starting method: Direct on line

Rated voltage (U): 3 x 400 V, 50 Hz

Voltage drop (ΔU): 3 %

Rated current (I): 64.0 A

Power factor ($\cos\varphi$): 0.85

Specific resistance (ρ): 0.02

Cross-section (q): 25 mm^2

$\sin\varphi$: 0.54

Inductive resistance (X_L): 0.078×10^{-3} [Ω/m]

$$L = \frac{400 \times 3}{64.0 \times 1.73 \times 100 \times (0.85 \times \frac{0.02}{25} + 0.54 \times 0.078 \times 10^{-3})}$$

L = 150 m.

Cable dimensions at 1 x 230 V, 50 Hz

Motor	kW	I_n [A]	1.5 mm^2	2.5 mm^2	4 mm^2	6 mm^2	10 mm^2
4"	0.37	4.0	111	185	295	440	723
	0.55	5.8	80	133	211	315	518
	0.75	7.5	58	96	153	229	377
	1.1	7.3	48	79	127	190	316
	1.5	10.2	34	57	92	137	228
	2.2	14	24	43	68	102	169

Maximum cable length in metres from motor starter to pump.

Cable dimensions at 3 x 400 V, 50 Hz, DOL

Voltage drop: 1 %

Motor	kW	I _n [A]	Cos φ 100 %	Dimensions [mm ²]																
				1.5	2.5	4	6	10	16	25	35	50	70	95	120	150	185	240	300	
4"	0.37	1.4	0.64	192	318	506	752													
4"	0.55	2.2	0.64	122	203	322	479	783												
4"	0.75	2.3	0.72	104	173	275	409	672												
4"	1.1	3.4	0.72	70	117	186	277	455	712											
4"	1.5	4.2	0.75	55	91	145	215	354	556	844										
4"	2.2	5.5	0.82	38	64	101	151	249	393	599	818									
4"	3.0	7.85	0.77	29	47	75	112	185	291	442	601	822								
4"	4.0	9.6	0.8	22	37	59	89	146	230	350	477	656	874							
4"	5.5	13	0.81	16	27	43	65	107	168	256	349	480	641	821	983					
4"	7.5	18.8	0.78		20	31	46	76	120	183	248	340	452	577	687	804	923			
6"	5.5	13.6	0.77	16	27	44	65	107	168	255	347	475	629	801	953					
6"	7.5	17.6	0.8	12	20	32	48	80	125	191	260	358	477	610	728	855	984			
6"	9.2	21.8	0.81		16	26	39	64	100	153	208	287	382	490	586	689	795	935		
6"	11	24.8	0.83		14	22	33	55	86	132	180	248	332	427	512	604	699	826	942	
6"	13	30	0.81			19	28	46	73	111	151	208	278	356	426	501	577	680	772	
6"	15	34	0.82				24	40	64	97	132	182	244	313	375	441	510	601	684	
6"	18.5	42	0.81				20	33	52	79	108	149	198	254	304	358	412	486	551	
6"	22	48	0.84					28	44	67	92	127	170	220	264	312	361	428	489	
6"	26	57	0.84					24	37	57	78	107	144	185	222	263	304	361	412	
6"	30	66.5	0.83						32	49	67	92	124	159	191	225	261	308	351	
6"	37	85.5	0.79							40	54	74	99	126	150	176	203	238	269	
8"	22	48	0.84					28	44	67	92	127	170	220	264	312	361	428	489	
8"	26	56.5	0.85					23	37	57	78	107	144	186	224	265	307	365	418	
8"	30	64	0.85						33	50	68	95	127	164	197	234	271	322	369	
8"	37	78.5	0.85						27	41	56	77	104	134	161	191	221	263	301	
8"	45	96.5	0.82							34	47	64	86	110	132	155	180	212	241	
8"	55	114	0.85								38	53	71	92	111	131	152	181	207	
8"	63	132	0.83									47	62	80	96	113	131	155	177	
8"	75	152	0.86									40	53	69	83	98	114	136	156	
8"	92	186	0.86										43	56	68	80	94	111	128	
8"	110	224	0.87											47	56	67	78	93	107	
10"	75	156	0.84										52	68	81	96	111	132	151	
10"	92	194	0.82										43	55	66	77	89	105	120	
10"	110	228	0.84											46	56	66	76	90	103	
10"	132	270	0.84												47	55	64	76	87	
10"	147	315	0.81													48	55	65	74	
10"	170	365	0.81															56	63	
10"	190	425	0.79																48	54
12"	147	305	0.83													49	57	67	77	
12"	170	345	0.85														50	60	68	
12"	190	390	0.84															53	60	
12"	220	445	0.85																53	
12"	250	505	0.85																	
Max. current for cable [A]*				18.5	25	34	43	60	80	101	126	153	196	238	276	319	364	430	497	

* At particularly favourable heat dissipation conditions.

Maximum cable length in metres from motor starter to pump.

Cable dimensions at 3 x 400 V, 50 Hz, DOL

Voltage drop: 3 %

Motor	kW	I _n [A]	Cos φ 100 %	Dimensions [mm ²]																					
				1.5	2.5	4	6	10	16	25	35	50	70	95	120	150	185	240	300						
4"	0.37	1.4	0.64	576	955																				
4"	0.55	2.2	0.64	366	608	966																			
4"	0.75	2.3	0.72	312	518	824																			
4"	1.1	3.4	0.72	211	350	558	830																		
4"	1.5	4.2	0.75	164	273	434	646																		
4"	2.2	5.5	0.82	115	191	304	453	748																	
4"	3.0	7.85	0.77	86	142	226	337	555	872																
4"	4.0	9.6	0.8	67	112	178	266	438	689																
4"	5.5	13	0.81	49	82	130	194	320	504	768															
4"	7.5	18.8	0.78		59	93	139	229	360	548	745														
6"	5.5	13.6	0.77	49	82	131	195	320	503	765															
6"	7.5	17.6	0.8	37	61	97	145	239	376	573	781														
6"	9.2	21.8	0.81		49	78	116	191	300	458	625	860													
6"	11	24.8	0.83		42	67	99	164	258	395	540	744	995												
6"	13	30	0.81			56	84	139	218	333	454	625	833												
6"	15	34	0.82				73	121	191	291	397	547	731	938											
6"	18.5	42	0.81				60	99	156	238	324	446	595	763	913										
6"	22	48	0.84					84	132	202	276	382	511	659	792	935									
6"	26	57	0.84						71	111	170	233	321	431	555	667	788	913							
6"	30	66.5	0.83							96	147	201	277	371	477	573	676	782	925						
6"	37	85.5	0.79								119	162	223	296	378	451	529	608	713	806					
8"	22	48	0.84						84	132	202	276	382	511	659	792	935								
8"	26	56.5	0.85						70	111	170	233	322	432	557	671	794	922							
8"	30	64	0.85							98	150	205	284	381	492	592	701	814	967						
8"	37	78.5	0.85							80	122	168	232	311	401	483	572	664	789	903					
8"	45	96.5	0.82								102	140	193	257	330	396	466	539	635	723					
8"	55	114	0.85									115	159	214	276	333	394	457	543	622					
8"	63	132	0.83										140	187	240	289	340	394	466	531					
8"	75	152	0.86											119	160	206	249	295	343	409	469				
8"	92	186	0.86												130	169	203	241	281	334	383				
8"	110	224	0.87													140	169	200	233	279	321				
10"	75	156	0.84													157	203	244	288	334	395	452			
10"	92	194	0.82														128	164	197	232	268	316	360		
10"	110	228	0.84															139	167	197	228	271	309		
10"	132	270	0.84																141	166	193	228	261		
10"	147	315	0.81																	143	165	194	221		
10"	170	365	0.81																			168	190		
10"	190	425	0.79																				143	162	
12"	147	305	0.83																			147	170	202	230
12"	170	345	0.85																				151	179	205
12"	190	390	0.84																					158	181
12"	220	445	0.85																						159
12"	250	505	0.85																						
Max. current for cable [A]*				18.5	25	34	43	60	80	101	126	153	196	238	276	319	364	430	497						

* At particularly favourable heat dissipation conditions.

Maximum cable length in metres from motor starter to pump.

Sizing of cable

Calculation of cable cross-section

Formula designations

U = Rated voltage [V]

ΔU = Voltage drop [%]

I = Rated current of the motor [A]

$\cos\varphi$ = Power factor

$\rho = 1/\chi$

Materials of cable:

Copper: $\chi = 52 \text{ m}/\Omega \times \text{mm}^2$

Aluminium: $\chi = 35 \text{ m}/\Omega \times \text{mm}^2$

q = Cross-section [mm^2]

$\sin\varphi = \sqrt{1 - \cos^2\varphi}$

$X_L =$ Inductive resistance $0.078 \times 10^{-3} \text{ } [\Omega/\text{m}]$

L = Length of cable [m]

$\Delta p =$ Power loss [W]

For calculation of the cross-section of the submersible drop cable, use this formula:

DOL

$$q = \frac{I \times 1.73 \times 100 \times L \times \rho \times \cos\varphi}{U \times \Delta U - (I \times 1.73 \times 100 \times L \times X_L \times \sin\varphi)}$$

Star-delta

$$q = \frac{I \times 100 \times L \times \rho \times \cos\varphi}{U \times \Delta U - (I \times 1.73 \times 100 \times L \times X_L \times \sin\varphi)}$$

The values of the rated current (I) and the power factor ($\cos\varphi$) can be read in the tables on pages 73 to 78.

Calculation of the power loss

For calculation of the power loss in the submersible drop cable, use this formula:

$$\Delta p = \frac{3 \times L \times \rho \times I^2}{q}$$

Example

Motor size: 45 kW, MMS 8000

Voltage: 3 x 400 V, 50 Hz

Starting method: Direct on line

Rated current (I_n): 96.5 A

Required cable length (L): 200 m

Water temperature: 30 °C.

Cable selection

Choice A: 3 x 150 mm^2

Choice B: 3 x 185 mm^2 .

Calculation of power loss

Choice A:

$$\Delta p_A = \frac{3 \times L \times \rho \times I^2}{q}$$

$$\Delta p_A = \frac{3 \times 200 \times 0.02 \times 96.5^2}{150}$$

$\Delta p_A = 745 \text{ W}$.

Choice B:

$$\Delta p_B = \frac{3 \times 200 \times 0.02 \times 96.5^2}{185}$$

$\Delta p_B = 604 \text{ W}$.

Savings

Operating hours/year: h = 4000.

Annual saving (A):

$A = (\Delta p_A - \Delta p_B) \times h = (745 \text{ W} - 604 \text{ W}) \times 4000 = 564000 \text{ Wh} = 564 \text{ kWh}$.

By choosing the cable size 3 x 185 mm^2 instead of 3 x 150 mm^2 , an annual saving of 564 kWh is achieved.

Operating time: 10 years.

Saving after 10 years (A_{10}):

$A_{10} = A \times 10 = 564 \times 10 = 5640 \text{ kWh}$.

The saving in amount must be calculated in the local currency.

Head losses in ordinary water pipes

Upper figures indicate the velocity of water in m/sec.

Lower figures indicate head loss in metres per 100 metres of straight pipes.

Quantity of water			Head losses in ordinary water pipes											
m ³ /h	Litres/min.	Litres/sec.	Nominal pipe diameter in inches and internal diameter in [mm]											
			1/2"	3/4"	1"	1 1/4"	1 1/2"	2"	2 1/2"	3"	3 1/2"	4"	5"	6"
			15.75	21.25	27.00	35.75	41.25	52.50	68.00	80.25	92.50	105.0	130.0	155.5
0.6	10	0.16	0.855 9.910	0.470 2.407	0.292 0.784									
0.9	15	0.25	1.282 20.11	0.705 4.862	0.438 1.570	0.249 0.416								
1.2	20	0.33	1.710 33.53	0.940 8.035	0.584 2.588	0.331 0.677	0.249 0.346							
1.5	25	0.42	2.138 49.93	1.174 11.91	0.730 3.834	0.415 1.004	0.312 0.510							
1.8	30	0.50	2.565 69.34	1.409 16.50	0.876 5.277	0.498 1.379	0.374 0.700	0.231 0.223						
2.1	35	0.58	2.993 91.54	1.644 21.75	1.022 6.949	0.581 1.811	0.436 0.914	0.269 0.291						
2.4	40	0.67		1.879 27.66	1.168 8.820	0.664 2.290	0.499 1.160	0.308 0.368						
3.0	50	0.83		2.349 41.40	1.460 13.14	0.830 3.403	0.623 1.719	0.385 0.544	0.229 0.159					
3.6	60	1.00		2.819 57.74	1.751 18.28	0.996 4.718	0.748 2.375	0.462 0.751	0.275 0.218					
4.2	70	1.12		3.288 76.49	2.043 24.18	1.162 6.231	0.873 3.132	0.539 0.988	0.321 0.287	0.231 0.131				
4.8	80	1.33			2.335 30.87	1.328 7.940	0.997 3.988	0.616 1.254	0.367 0.363	0.263 6.164				
5.4	90	1.50			2.627 38.30	1.494 9.828	1.122 4.927	0.693 1.551	0.413 0.449	0.269 0.203				
6.0	100	1.67			2.919 46.49	1.660 11.90	1.247 5.972	0.770 1.875	0.459 0.542	0.329 0.244	0.248 0.124			
7.5	125	2.08			3.649 70.41	2.075 17.93	1.558 8.967	0.962 2.802	0.574 0.809	0.412 0.365	0.310 0.185	0.241 0.101		
9.0	150	2.50			2.490 25.11	1.870 12.53	1.154 3.903	0.668 1.124	0.494 0.506	0.372 0.256	0.289 0.140			
10.5	175	2.92			2.904 33.32	2.182 16.66	1.347 5.179	0.803 1.488	0.576 0.670	0.434 0.338	0.337 0.184			
12	200	3.33			3.319 42.75	2.493 21.36	1.539 6.624	0.918 1.901	0.659 0.855	0.496 0.431	0.385 0.234	0.251 0.084		
15	250	4.17			4.149 64.86	3.117 32.32	1.924 10.03	1.147 2.860	0.823 1.282	0.620 0.646	0.481 0.350	0.314 0.126		
18	300	5.00				3.740 45.52	2.309 14.04	1.377 4.009	0.988 1.792	0.744 0.903	0.577 0.488	0.377 0.175	0.263 0.074	
24	400	6.67				4.987 78.17	3.078 24.04	1.836 6.828	1.317 3.053	0.992 1.530	0.770 0.829	0.502 0.294	0.351 0.124	
30	500	8.33					3.848 36.71	2.295 10.40	1.647 4.622	1.240 2.315	0.962 1.254	0.628 0.445	0.439 0.187	
36	600	10.0					4.618 51.84	2.753 14.62	1.976 6.505	1.488 3.261	1.155 1.757	0.753 0.623	0.526 0.260	
42	700	11.7						3.212 19.52	2.306 8.693	1.736 4.356	1.347 2.345	0.879 0.831	0.614 0.347	
48	800	13.3						3.671 25.20	2.635 11.18	1.984 5.582	1.540 3.009	1.005 1.066	0.702 0.445	
54	900	15.0						4.130 31.51	2.964 13.97	2.232 6.983	1.732 3.762	1.130 1.328	0.790 0.555	
60	1000	16.7						4.589 38.43	3.294 17.06	2.480 8.521	1.925 4.595	1.256 1.616	0.877 0.674	
75	1250	20.8							4.117 26.10	3.100 13.00	2.406 7.010	1.570 2.458	1.097 1.027	
90	1500	25.0							4.941 36.97	3.720 18.42	2.887 9.892	1.883 3.468	1.316 1.444	
105	1750	29.2							4.340 24.76	3.368 13.30	2.197 4.665	1.535 1.934		
120	2000	33.3							4.960 31.94	3.850 17.16	2.511 5.995	1.754 2.496		
150	2500	41.7								4.812 26.26	3.139 9.216	2.193 3.807		
180	3000	50.0									3.767 13.05	2.632 5.417		
240	4000	66.7									5.023 22.72	3.509 8.926		
300	5000	83.3										4.386 14.42		
90° bends, slide valves			1.0	1.0	1.1	1.2	1.3	1.4	1.5	1.6	1.6	1.7	2.0	2.5
T-pieces, non-return valves			4.0	4.0	4.0	5.0	5.0	5.0	6.0	6.0	6.0	7.0	8.0	9.0

The table is calculated in accordance with H. Lang's new formula $a = 0.02$ and for a water temperature of 10 °C.

The head loss in bends, slide valves, T-pieces and non-return valves is equivalent to the metres of straight pipes stated in the last two lines of the table. To find the head loss in foot valves multiply the loss in T-pieces by two.

Table of head losses

SP A, SP

Head losses in plastic pipes

Upper figures indicate the velocity of water in m/sec.

Lower figures indicate head loss in metres per 100 metres of straight pipes.

Quantity of water			PELM/PEH PN 10											
m ³ /h	Litres/min.	Litres/sec.	PELM					PEH						
			25	32	40	50	63	75	90	110	125	140	160	180
			20.4	26.2	32.6	40.8	51.4	61.4	73.6	90.0	102.2	114.6	130.8	147.2
0.6	10	0.16	0.49 1.8	0.30 0.66	0.19 0.27	0.12 0.085								
0.9	15	0.25	0.76 4.0	0.46 1.14	0.3 0.6	0.19 0.18	0.12 0.63							
1.2	20	0.33	1.0 6.4	0.61 2.2	0.39 0.9	0.25 0.28	0.16 0.11							
1.5	25	0.42	1.3 10.0	0.78 3.5	0.5 1.4	0.32 0.43	0.2 0.17	0.14 0.074						
1.8	30	0.50	1.53 13.0	0.93 4.6	0.6 1.9	0.38 0.57	0.24 0.22	0.17 0.092						
2.1	35	0.58	1.77 16.0	1.08 6.0	0.69 2.0	0.44 0.70	0.28 0.27	0.2 0.12						
2.4	40	0.67	2.05 22.0	1.24 7.5	0.80 3.3	0.51 0.93	0.32 0.35	0.23 0.16	0.16 0.063					
3.0	50	0.83	2.54 37.0	1.54 11.0	0.99 4.8	0.63 1.40	0.4 0.50	0.28 0.22	0.2 0.09					
3.6	60	1.00	3.06 43.0	1.85 15.0	1.2 6.5	0.76 1.90	0.48 0.70	0.34 0.32	0.24 0.13	0.16 0.050				
4.2	70	1.12	3.43 50.0	2.08 18.0	1.34 8.0	0.86 2.50	0.54 0.83	0.38 0.38	0.26 0.17	0.18 0.068				
4.8	80	1.33		2.47 25.0	1.59 10.5	1.02 3.00	0.64 1.20	0.45 0.50	0.31 0.22	0.2 0.084				
5.4	90	1.50		2.78 30.0	1.8 12.0	1.15 3.50	0.72 1.30	0.51 0.57	0.35 0.26	0.24 0.092	0.18 0.05			
6.0	100	1.67		3.1 39.0	2.0 16.0	1.28 4.6	0.8 1.80	0.56 0.73	0.39 0.30	0.26 0.12	0.2 0.07			
7.5	125	2.08		3.86 50.0	2.49 24.0	1.59 6.6	1.00 2.50	0.70 1.10	0.49 0.50	0.33 0.18	0.25 0.10	0.20 0.055		
9.0	150	2.50			3.00 33.0	1.91 8.6	1.20 3.5	0.84 1.40	0.59 0.63	0.39 0.24	0.30 0.13	0.24 0.075		
10.5	175	2.92			3.5 38.0	2.23 11.0	1.41 4.3	0.99 1.80	0.69 0.78	0.46 0.30	0.36 0.18	0.28 0.09		
12	200	3.33			3.99 50.0	2.55 14.0	1.60 5.5	1.12 2.40	0.78 1.0	0.52 0.40	0.41 0.22	0.32 0.12	0.25 0.065	
15	250	4.17				3.19 21.0	2.01 8.0	1.41 3.70	0.98 1.50	0.66 0.57	0.51 0.34	0.40 0.18	0.31 0.105	0.25 0.06
18	300	5.00				3.82 28.0	2.41 10.5	1.69 4.60	1.18 1.95	0.78 0.77	0.61 0.45	0.48 0.25	0.37 0.13	0.29 0.085
24	400	6.67					3.21 19.0	2.25 8.0	1.57 3.60	1.05 1.40	0.81 0.78	0.65 0.44	0.50 0.23	0.39 0.15
30	500	8.33					4.01 28.0	2.81 11.5	1.96 5.0	1.31 2.0	1.02 1.20	0.81 0.63	0.62 0.33	0.49 0.21
36	600	10.0					4.82 37.0	3.38 15.0	2.35 6.6	1.57 2.60	1.22 1.50	0.97 0.82	0.74 0.45	0.59 0.28
42	700	11.7					5.64 47.0	3.95 24.0	2.75 8.0	1.84 3.50	1.43 1.90	1.13 1.10	0.87 0.60	0.69 0.40
48	800	13.3					4.49 26.0	3.13 11.0	2.09 4.5	1.62 2.60	1.29 1.40	0.99 0.81	0.78 0.48	
54	900	15.0					5.07 33.0	3.53 13.5	2.36 5.5	1.83 3.20	1.45 1.70	1.12 0.95	0.08 0.58	
60	1000	16.7					5.64 40.0	3.93 16.0	2.63 6.7	2.04 3.90	1.62 2.2	1.24 1.2	0.96 0.75	
75	1250	20.8						4.89 25.0	3.27 9.0	2.54 5.0	2.02 3.0	1.55 1.6	1.22 0.95	
90	1500	25.0						5.88 33.0	3.93 13.0	2.63 8.0	2.04 4.1	1.62 2.3	1.24 1.40	0.96 0.75
105	1750	29.2						6.86 44.0	4.59 17.5	3.56 9.7	2.83 5.7	2.17 3.2	1.72 1.9	
120	2000	33.3							5.23 23.0	4.06 13.0	3.23 7.0	2.48 4.0	1.96 2.4	
150	2500	41.7							6.55 34.0	5.08 18.0	4.04 10.5	3.10 6.0	2.45 3.5	
180	3000	50.0							7.86 45.0	6.1 27.0	4.85 14.0	3.72 7.6	2.94 4.4	
240	4000	66.7								8.13 43.0	6.47 24.0	4.96 13.0	3.92 7.5	
300	5000	83.3									8.08 33.0	6.2 18.0	4.89 11.0	

The table is based on a nomogram.

Roughness: K = 0.01 mm.

Water temperature: t = 10 °C.

WebCAPS

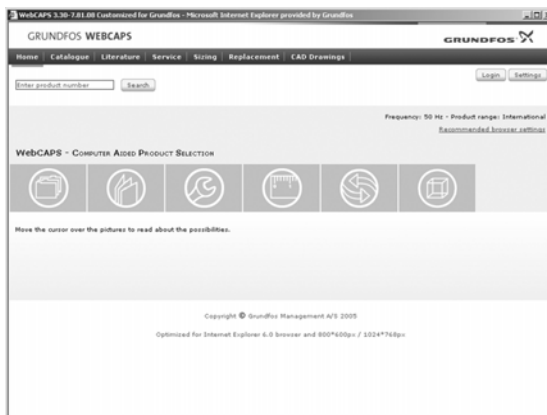

WebCAPS is a **Web-based Computer Aided Product Selection** program available on www.grundfos.com.

WebCAPS contains detailed information on more than 185,000 Grundfos products in more than 20 languages.

In WebCAPS, all information is divided into six sections:

- Catalogue
- Literature
- Service
- Sizing
- Replacement
- CAD drawings.

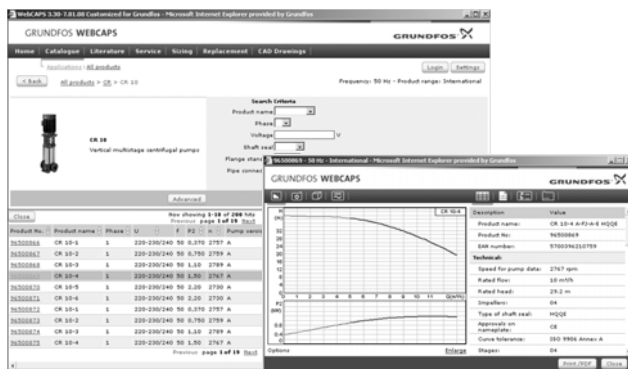

Catalogue

This section is based on fields of application and pump types, and contains

- technical data
- curves (QH, Eta, P1, P2, etc.) which can be adapted to the density and viscosity of the pumped liquid and show the number of pumps in operation
- product photos
- dimensional drawings
- wiring diagrams
- quotation texts, etc.

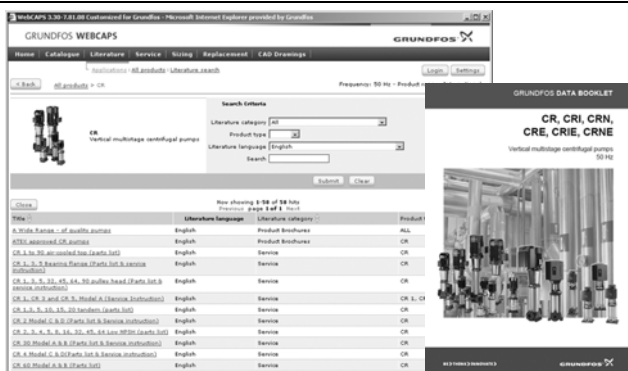

Literature

In this section you can access all the latest documents of a given pump, such as

- data booklets
- installation and operating instructions
- service documentation, such as Service kit catalogue and Service kit instructions
- quick guides
- product brochures, etc.



Service

This section contains an easy-to-use interactive service catalogue. Here you can find and identify service parts of both existing and discontinued Grundfos pumps.

Furthermore, this section contains service videos showing you how to replace service parts.

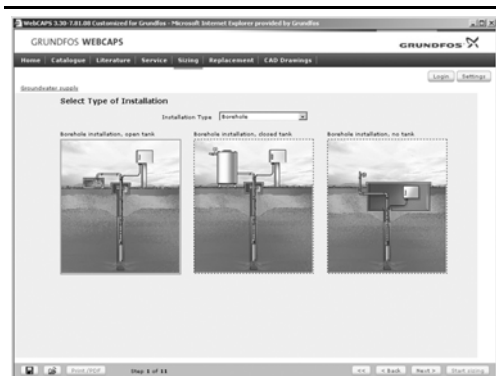

Sizing

This section is based on different fields of application and installation examples, and gives easy step-by-step instructions in how to:

- select the most suitable and efficient pump for your installation
- carry out advanced calculations based on energy consumption, payback periods, load profiles, life cycle costs, etc.
- analyse your selected pump via the built-in life cycle cost tool
- determine the flow velocity in wastewater applications, etc.



Replacement

In this section you find a guide to selecting and comparing replacement data of an installed pump in order to replace the pump with a more efficient Grundfos pump.

The section contains replacement data of a wide range of pumps produced by other manufacturers than Grundfos.

Based on an easy step-by-step guide, you can compare Grundfos pumps with the one you have installed on your site. When you have specified the installed pump, the guide will suggest a number of Grundfos pumps which can improve both comfort and efficiency.

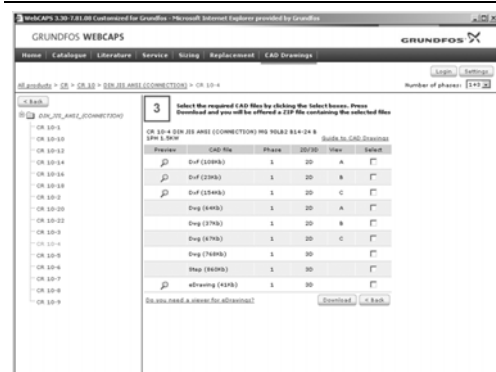

CAD drawings

In this section it is possible to download two-dimensional (2D) and three-dimensional (3D) CAD drawings of most Grundfos pumps.

These formats are available in WebCAPS:

- Two-dimensional drawings:
- .dxf, wireframe drawings
 - .dwg, wireframe drawings.

- Three-dimensional drawings:
- .dwg, wireframe drawings (without surfaces)
 - .stp, solid drawings (with surfaces)
 - .eprt, E-drawings.

WinCAPS



Fig. 28 WinCAPS CD-ROM

WinCAPS is a **Windows-based Computer Aided Product Selection** program containing detailed information on more than 185,000 Grundfos products in more than 20 languages.

The program contains the same features and functions as WebCAPS, but is an ideal solution if no Internet connection is available.

WinCAPS is available on CD-ROM and updated once a year.

Subject to alterations.

V7023747 0210	GB
Repl. V7023747 0907	

The name Grundfos, the Grundfos logo, and the payoff Be-Think-Innovate are registered trademarks owned by Grundfos Management A/S or Grundfos A/S, Denmark. All rights reserved worldwide.